

CENTRAL JAPAN RAILWAY COMPANY FACT SHEETS **2020**

ファクトシート

見通し等に関する注意事項

“ファクトシート 2020”に記載されている将来の計画や見込み数値等は、当社が現在入手可能な情報に基づく見通しであり、リスクや不確実性を含んでいます。潜在的なリスクや不確実性の例としては、経済動向や事業環境、消費動向、当社および子会社における他社との競合状況、法律や規制等の変更などが挙げられます。このファクトシートは、原則として令和2(2020)年5月末時点の情報に基づき、作成されています。

注 1.金額は単位未満を切り捨て、その他の数値は単位未満を四捨五入して表示しています。
2.FY2019は2019年度を表します。

Forward-Looking Statements

Forward-looking statements and forecasts, etc. contained in the fact sheets are future prospects based on information available at the time of preparation of this document and include risks and uncertainties. Examples of latent risks and uncertainties include; economic conditions, business environment, consumer trends, status of competition between the Company and its subsidiaries and other firms. Changes to laws and regulations, etc., may also be cited.

This fact sheet is compiled based on information available as of the end of May 2020, in principle.

Note: 1.Figures of financial information are truncated, while statistical data and all percentages are rounded.
2.FY2019 refers to the one-year period ending March 31, 2020.

事業概要 Overview of JR Central's Operations

営業エリア Operating Areas

当社は、東京、名古屋、大阪間を結ぶ日本の交通の大動脈である東海道新幹線、及び名古屋・静岡地区の都市圏輸送を中心とした12線区の在来線を運営しています。

JR Central operates the Tokaido Shinkansen, the main transportation artery linking Tokyo, Nagoya, and Osaka, and a network of 12 conventional lines centered on the Nagoya and Shizuoka City areas.

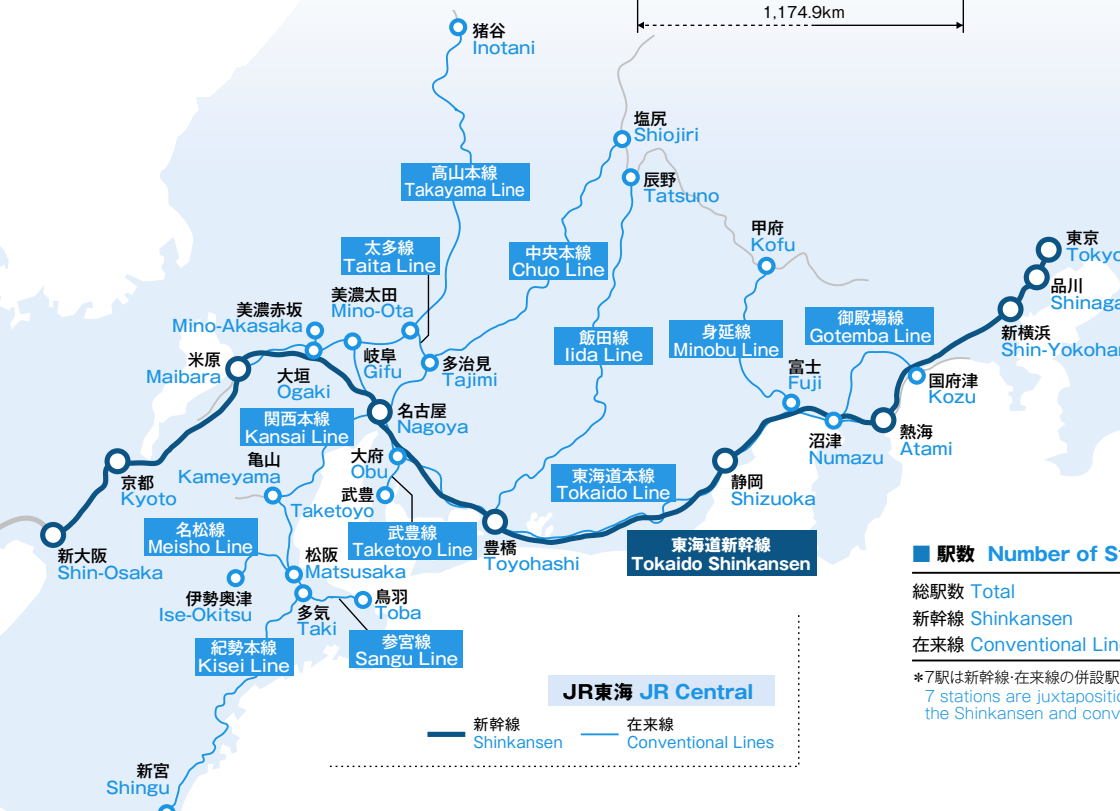
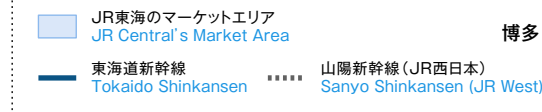

駅数 Number of Stations

総駅数 Total	405 *
新幹線 Shinkansen	17
在来線 Conventional Line	395

*7駅は新幹線・在来線の併設駅
7 stations are juxtapositional stations of the Shinkansen and conventional line.

当社マーケットエリアが日本全体に占める割合 Percentages of our market area in Japan as a whole

面積 Area

(令和2(2020)年1月 As of January 2020)

人口 Population

(令和2(2020)年1月1日 As of January 1, 2020)

県別総生産 Prefectural GDP (名目GDP Nominal GDP)

(平成29(2017)年3月期 FY2016)

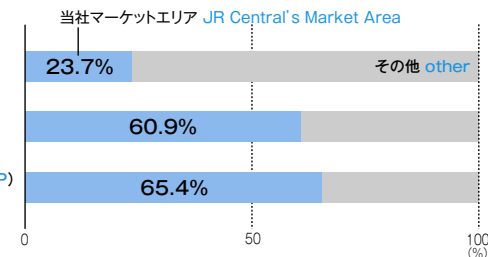

日本国土：約380,000km²

人口：1.27億人(令和2(2020)年1月1日現在)

注 当社マーケットエリアは以下の都府県を対象として計算

東京都、神奈川県、千葉県、埼玉県、茨城県、静岡県、山梨県、長野県、愛知県、三重県、岐阜県、滋賀県、大阪府、京都府、兵庫県、奈良県

面積：国土地理院「全国都道府県市区町村別面積調」

人口：総務省「住民基本台帳に基づく人口、人口動態及び世帯数」

県別総生産：内閣府「県民経済計算」

Area of Japan: Approx. 380,000 km²

Population: 127 million (As of January 1, 2020)

Notes: JR Central's market area is calculated taking the following prefectures into account.

Tokyo, Kanagawa, Chiba, Saitama, Ibaraki, Shizuoka, Yamanashi, Nagano, Aichi, Mie, Gifu, Shiga, Osaka, Kyoto, Hyogo, Nara

Source: Area: Geospatial Information Authority of Japan "Areas of Prefectures and Municipalities in Japan"

Population: Ministry of Internal Affairs and Communications "Population, Demographics and Number of Households Derived from Basic Resident Registration"

Total production by prefecture: Cabinet Office "Report on Prefectural Accounts"

営業キロ Route Length (km)

東海道新幹線 Tokaido Shinkansen	552.6
在来線 Conventional Line	1,418.2
東海道本線 Tokaido Line	360.1
御殿場線 Gotemba Line	60.2
身延線 Minobu Line	88.4
飯田線 Iida Line	195.7
武豊線 Taketoyo Line	19.3
高山本線 Takayama Line	189.2
中央本線 Chuo Line	174.8
太多線 Taita Line	17.8
関西本線 Kansai Line	59.9
紀勢本線 Kisei Line	180.2
名松線 Meisho Line	43.5
参宮線 Sangu Line	29.1
合計 Total	1,970.8

乗車人員ベスト10駅(1日当たり) Top 10 Stations in terms of Number of Average Daily Passengers

(千人 令和元(2019)年度 thousand passengers, FY2019)

名古屋 Nagoya	216(70)
東京 Tokyo	98
新大阪 Shin-Osaka	80
金山 Kanayama	71
静岡 Shizuoka	59(20)
浜松 Hamamatsu	37(13)
京都 Kyoto	37
刈谷 Kariya	37
品川 Shinagawa	36
新横浜 Shin-Yokohama	33

注 ()内及び東京・新大阪・京都・品川・新横浜については新幹線のみ乗車人員

Note: The figures in parentheses and the figures for Tokyo, Shin-Osaka, Kyoto, Shinagawa and Shin-Yokohama indicate only Shinkansen passengers.

流通業 Merchandise and Other

営業収益 Operating Revenue **2,632** 営業利益 Operating Income **74**

JRセントラルタワーズ内で百貨店事業を営むほか、主に、車内・駅構内における物品販売等を行っています。

Includes a department store in JR central towers, retail sales in trains, stations, and others.

主な連結子会社 Main Consolidated Subsidiaries

(株)ジェイアール東海高島屋 JR Tokai Takashimaya Co., Ltd	東海キヨスク(株) Tokai Kiosk Company
(株)ジェイアール東海パッセンジャーズ JR-CENTRAL PASSENGERS Co., Ltd.	ジェイアール東海商事(株) JR Tokai Corporation

不動産業 Real Estate

営業収益 Operating Revenue **799** 営業利益 Operating Income **190**

駅ビル等不動産賃貸事業のほか、不動産分譲事業を行っています。
Includes real estate leasing business, such as station building leasing, and real estate sales in lots.

主な連結子会社 Main Consolidated Subsidiaries

ジェイアールセントラルビル(株) JR CENTRAL BUILDING CO., LTD.	東京ステーション開発(株) Tokyo Station Development Co., Ltd.
ジェイアール東海不動産(株) JR Tokai Real Estate Co., Ltd.	名古屋ステーション開発(株) Nagoya Station Area Development Corporation
新横浜ステーション開発(株) Shin-Yokohama Station Development Co., Ltd.	ジェイアール東海関西開発(株) JR Development and Management Corporation of Kansai

運輸業 Transportation

営業収益 Operating Revenue **14,312** 営業利益 Operating Income **6,176**

東海道新幹線及び東海地方の在来線における鉄道事業を行うほか、バス事業等を行っています。
Manages JR Central's railway operations, such as the Tokaido Shinkansen and conventional railway operations in the Tokai area, bus operations, and others.

主な連結子会社 Main Consolidated Subsidiaries

ジェイアール東海バス(株) JR Tokai Bus Company

その他 Other

営業収益 Operating Revenue **2,722** 営業利益 Operating Income **135**

当社の主要駅等でホテル業を行うほか、旅行業、広告業、鉄道車両等製造業及び建設業等を行っています。
Includes hotels in our main stations, travel, advertising, rolling stock production, and construction which are not included in other reportable segments.

主な連結子会社 Main Consolidated Subsidiaries

(株)ジェイアール東海ホテルズ JR Tokai Hotels Co., Ltd.	日本車輛製造(株) NIPPON SHARYO, LTD.	日本機械保線(株) The Japan Mechanised Works and Maintenance of Way Co. LTD
(株)ジェイアール東海ツアーズ JR Tokai Tours	ジェイアール東海建設(株) JR TOKAI CONSTRUCTION Co., Ltd.	東海交通機械(株) Tokai Rolling Stock & Machinery Co., Ltd.
(株)ジェイアール東海エージェンシー JR TOKAI AGENCY CO., LTD.	中央リネンサプライ(株) CHUO LINEN SUPPLY Co., Ltd.	

■ 収益構造(連結)
Consolidated Operating Revenue Composition

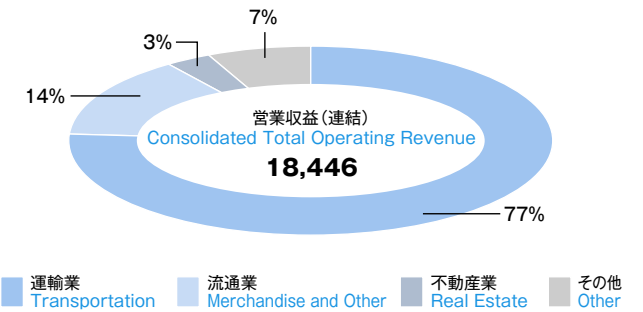

■ 利益構造(連結)
Consolidated Operating Income Composition

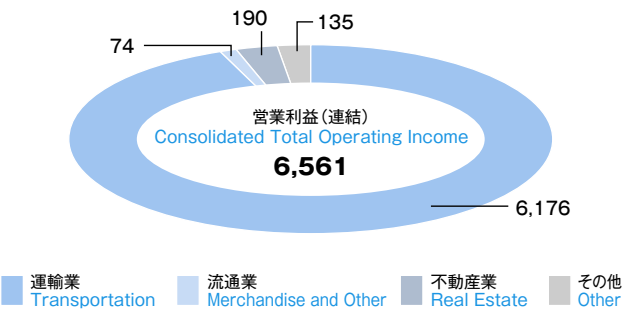

■ 運輸収入の内訳(単体)
Breakdown of Transportation Revenue (Non-Consolidated)

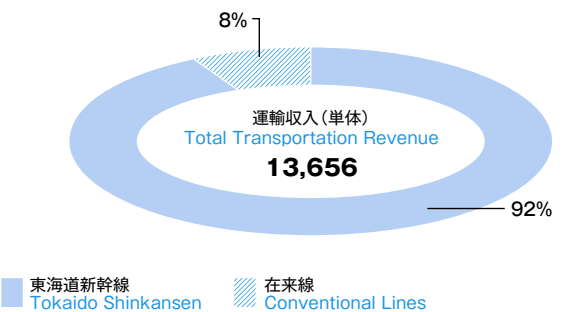

注 1.セグメント別の営業収益は、外部売上高のほか、他セグメントへの売上高も含む
2.連結の比率は外部売上高に基づく
3.営業利益(連結)6,561億円にはセグメント間取引の相殺消去△13億円を含む

Notes: 1.Operating revenues of each segment includes the amount of sales to other reportable segments as well as the amount of sales to external customers.
2.Consolidated operating revenues composition is based on revenue from external customers.
3.Consolidated total operating income 656.1 billion yen includes the reconciliations amount of △1.3 billion yen for segment profit which is the elimination of intersegment transactions.

東海道新幹線の状況(1) The Tokaido Shinkansen (1)

東海道新幹線の列車本数および利用状況(1日当たり) Daily Departures and Passenger Volume for the Tokaido Shinkansen

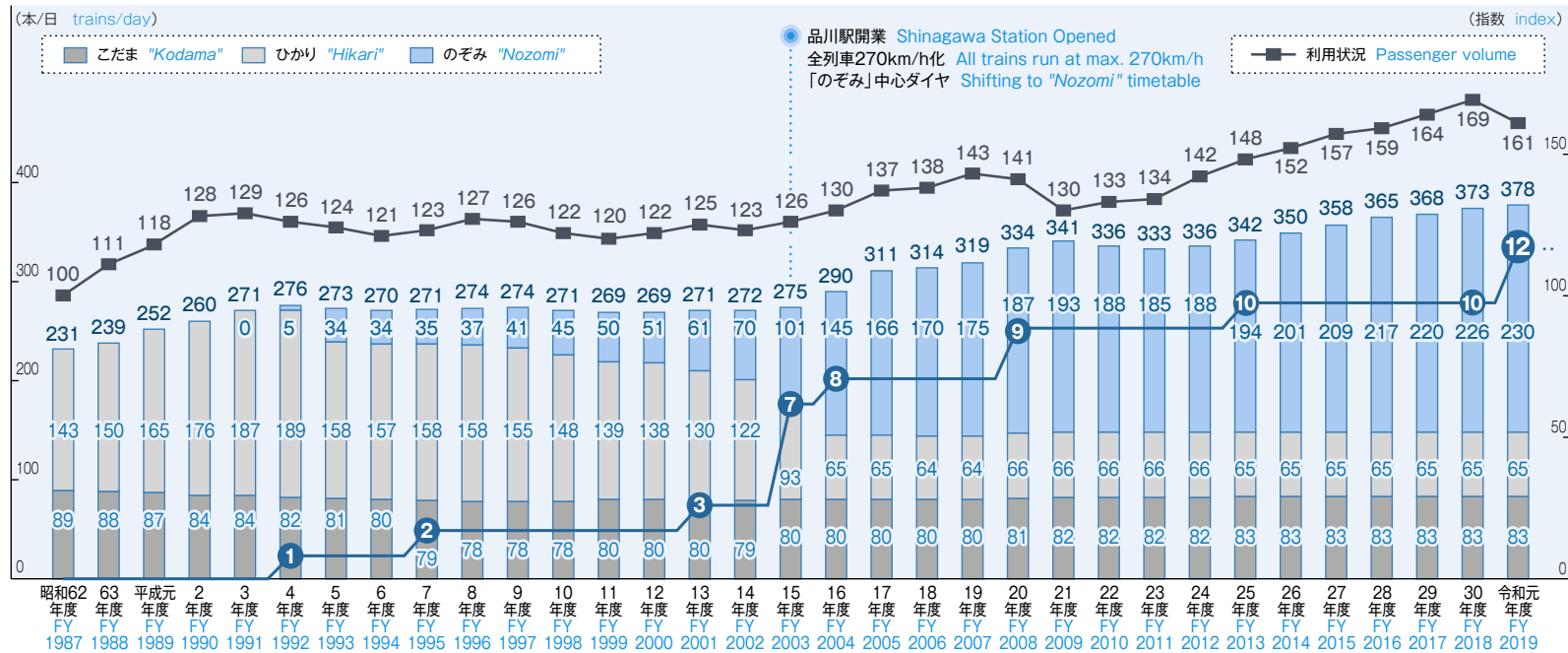

最速列車「のぞみ」の片道最大運転本数/時間
 Hourly departure(s) of our fastest train "Nozomi" at maximum (one-way)

- 注
1. 臨時列車を含む運転本数の実数
 2. 利用状況は断面輸送量について昭和62(1987)年度を100とした場合の指数
 3. 途中停車駅のぞみ: 品川、新横浜、名古屋、京都
 ひかり: 「のぞみ」停車駅とそれ以外の一部の駅
 こだま: 各駅
 4. 端数処理により、のぞみ・ひかり・こだまの合計が合計と一致しない場合があります。
- Note:
1. Including extra trains
 2. Passenger volumes are the indices of the total passenger volume at certain points. FY1987=100
 3. Stops
 "Nozomi": Shinagawa, Shin-Yokohama, Nagoya and Kyoto
 "Hikari": Same as Nozomi, plus a few additional stations
 "Kodama": Every station
 4. The figures of "Nozomi", "Hikari", and "Kodama" do not always equal the totals due to rounding.

東海道新幹線の輸送人キロとGDPの推移 Tokaido Shinkansen Passenger-kilometers and Japan's GDP

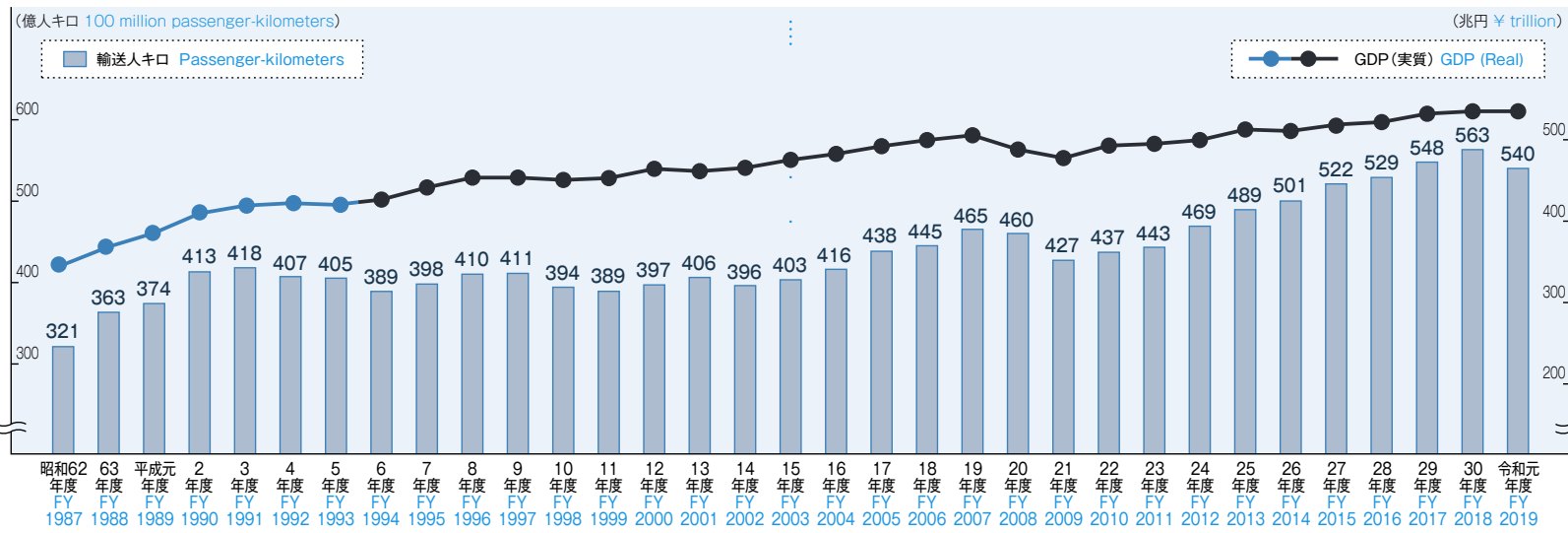

- 注
- GDPは、昭和62(1987)年度~平成5(1993)年度までは、平成12暦年連鎖価格と平成23暦年連鎖価格を用いて当社が算出した値。平成6(1994)年度~令和元(2019)年度までは平成23暦年連鎖価格。
- GDP: 「国民経済計算」(内閣府)
- 出典: JR Central, using the chain-linked GDP (benchmark year=2000) and the chain-linked GDP (benchmark year = 2011).
 Note: GDPs from FY1987 to FY1993 are calculated by JR Central, using the chain-linked GDP (benchmark year=2000) and the chain-linked GDP (benchmark year = 2011). GDPs from FY1994 to FY2019 are the chain-linked GDPs (benchmark year=2011)
- Source: GDP — Annual Report on National Accounts, Cabinet Office, Government of Japan

東海道新幹線の車種別編成数の推移 Shifts in the Type and Number of Rolling Stock for the Tokaido Shinkansen

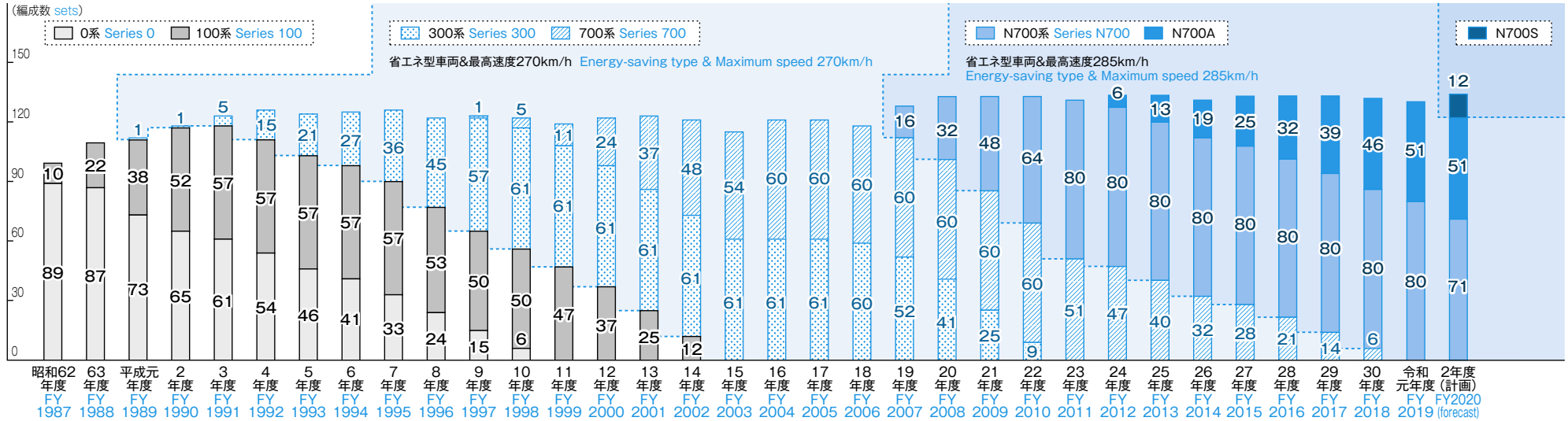

注 1. 数値は各年度末時点の編成数(保留車等を除く) Notes: 1. The figures are as of the end of each fiscal year (excluding retained trains, etc.)
 2. N700系は改造工事により285km/h化 2. Series N700 increased maximum speed from 270 km/h to 285 km/h after modification.

東海道新幹線の競争力強化の取組み Strengthening Competitiveness of the Tokaido Shinkansen

大動脈輸送の発展に向けた施策 Key issues for the development of Japan's main transportation artery

輸送力増強、品川駅新設工事、車両性能の統一等に取り組む
 Increasing capacity, Construction of Shinagawa Station, Unification of train capability, etc.

- 品川駅開業 Shinagawa Station Opened
- 全列車270km/h化 All trains run at max. 270km/h
- 「のぞみ」中心ダイヤ Shifting to "Nozomi" timetable
- 新大阪駅大規模改良工事の完了 Completion of the large-scale renovation of Shin-Osaka Station
- 最高速度285km/hへの速度向上 Increasing maximum speed to 285km/h
- 全車両N700Aタイプへの統一による「のぞみ」12本ダイヤの実現 Standardize all rolling stock to the N700A type and start twelve "Nozomi" timetable

新型車両の導入(最高速度) Introduction of new series of rolling stock (Maximum Speed)

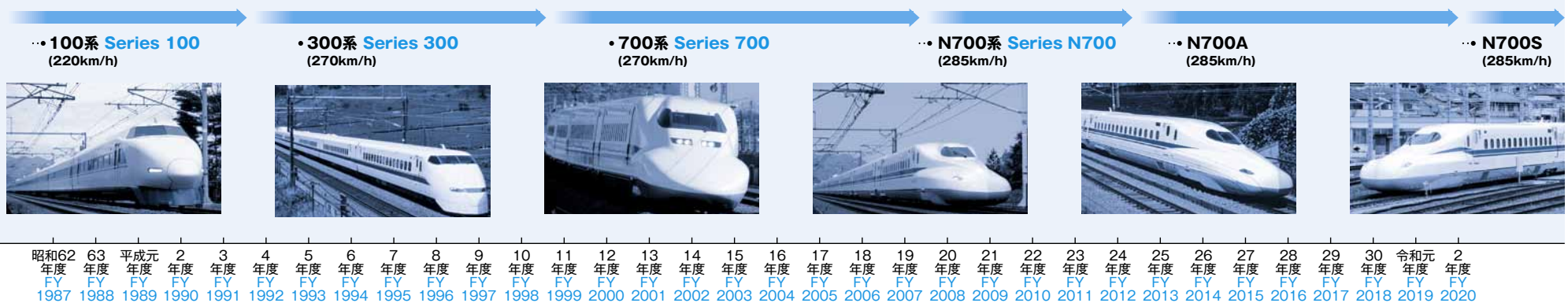

東海道新幹線の状況(2) The Tokaido Shinkansen (2)

現在のマーケットシェア(対航空) Updated Market Share (against Airlines)

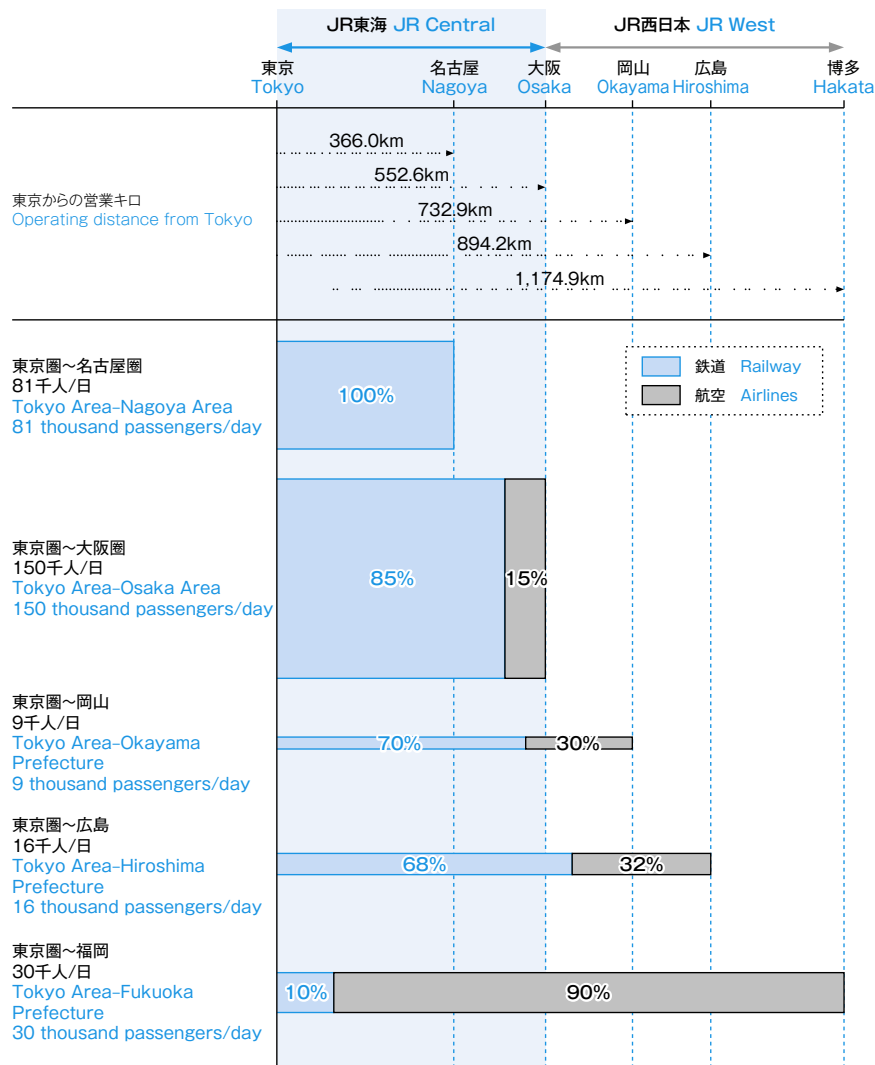

注 1.マーケットシェア：平成30(2018)年3月期旅客地域流動調査(国土交通省)をベースに当社が算出
 2.東京圏：東京都、神奈川県、千葉県、埼玉県、茨城県
 名古屋圏：愛知県、岐阜県、三重県
 大阪圏：大阪府、京都府、兵庫県、奈良県

Notes: 1. Market share is calculated by JR Central based on the inter-prefectural data of the inter-Regional Passenger Mobility Survey, published by the Ministry of Land, Infrastructure, Transport and Tourism (FY2017).

2. Tokyo Area: Tokyo, Kanagawa, Chiba, Saitama, Ibaraki
 Nagoya Area: Aichi, Gifu, Mie
 Osaka Area: Osaka, Kyoto, Hyogo, Nara

「エクスプレス予約」会員数・「スマートEX」登録者数と利用件数の推移 Number of "Express Reservation" Members, Persons Registered to "smartEX", and Usage per day

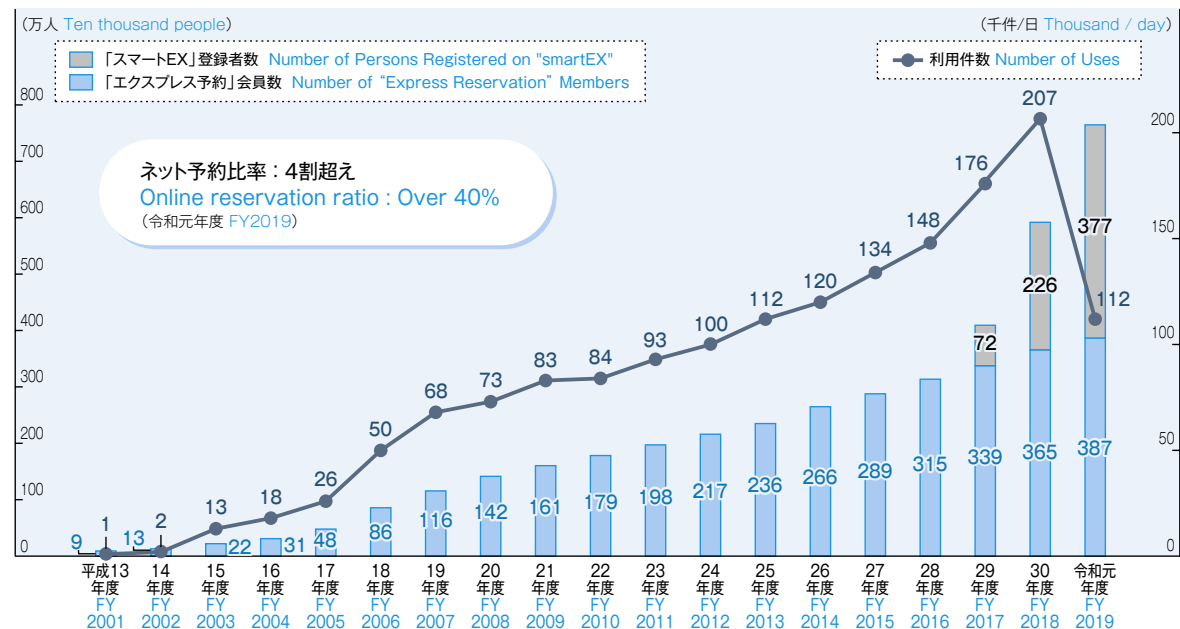

注 1.会員数は各年度末の実績で、JR東海及びJR西日本の合計
 2.利用件数は各年度の3月単月の実績。令和元年度は新型コロナウイルス感染症の影響により、数値が低くなっています。
 Notes: 1. The membership numbers are as of the end of each fiscal year and include the total of JR Central and JR West.
 2. Numbers of uses are results for March of each year. Number of uses for FY2019 has decreased because of the impacts of COVID-19 pandemic.

航空輸送サービスとの比較 Comparison with Airline Transportation Services

(令和2(2020)年4月現在 As of April 2020)

		東京～(営業キロ) Between Tokyo and ... (Operating distance)	大阪(552.6km) Osaka	岡山(732.9km) Okayama	広島(894.2km) Hiroshima	福岡(1,174.9km) Fukuoka
移動時間 ※1 Travel Time	新幹線 Shinkansen	2時間21分 ※3 2 hr 21 min	3時間9分 3 hr 9 min	3時間46分 3 hr 46 min	4時間52分 ※4 4 hr 52 min	
	航空 ※2 Airlines	1時間5分 (約2時間40分) 1 hr 5 min (Approx. 2 hr 40 min)	1時間10分 (約3時間) 1 hr 10 min (Approx. 3 hr)	1時間20分 (約3時間20分) 1 hr 20 min (Approx. 3 hr 20 min)	1時間30分 (約2時間50分) 1 hr 30 min (Approx. 2 hr 50 min)	
列車本数・ 発着便数/日 Arrivals & Departures Per day	新幹線 ※5 Shinkansen	250	128	100	69	
	航空 Airlines	113	20	34	140	

注 1.移動時間は最速列車または最速便による
 2.()内は市中・空港間のアクセス時間等を含む
 3.東京～新大阪間の移動時間
 4.東京～博多間の移動時間
 5.列車本数は臨時列車を除く
 Notes: 1. Travel times are in case of the fastest service
 2. Travel times in parentheses include transfer and access time between airports and city centers
 3. Travel time between Tokyo and Shin-Osaka stations
 4. Travel time between Tokyo and Hakata stations
 5. Excluding extra services

東海道新幹線の特徴 Characteristics of the Tokaido Shinkansen

安全 Safety	<ul style="list-style-type: none"> 開業以来、乗車中のお客様が死傷される列車事故ゼロ 人材教育・訓練による安全意識・技能の向上 安全関連設備への継続的投資 No accidents resulting in fatalities or injuries of passengers onboard since operations commenced Highly-skilled personnel with safety awareness through comprehensive training Continuous safety-related investments
正確 Punctuality	<ul style="list-style-type: none"> 平均遅延時分 0.2分／運行1列車(令和元(2019)年度) 注 自然災害等による遅延も含む Average delay 0.2 min/operational train (FY2019) Note: including delays due to uncontrollable causes such as natural disasters
高速 High Speed	<ul style="list-style-type: none"> 最高速度 285km/h 東京～新大阪間 2時間21分(令和2(2020)年3月ダイヤ改正時点(最速列車による到達時間)) Maximum operating speed of 285 km/h 2 hours and 21 minutes between Tokyo and Shin-Osaka (Based on the travel time of the fastest Shinkansen train, as of March 2020)
高頻度・大量 High Frequency and High Capacity	<ul style="list-style-type: none"> 列車本数 378本／日(令和元(2019)年度(臨時列車を含む)) 1日当たり輸送力:約37万席(新幹線)…約3万席(航空)(東京圏～大阪圏 令和2(2020)年4月現在) 座席数:1,323席／列車 輸送人員:458千人／日、168百万人／年(令和元(2019)年度) 378 trains/day (FY2019, average daily departures, including extra trains) Daily passenger capacity: Approx. 370 thousand seats for Shinkansen vs. approx. 30 thousand seats for airlines (between Tokyo Area and Osaka Area, as of April 2020) 1,323 seats/train Passenger Ridership: 458 thousand passengers/day, 168 million passengers/year (FY2019)
環境適合性 Environmental Suitability	<ul style="list-style-type: none"> 高いエネルギー効率、少ないCO₂排出量 (東海道新幹線(N700系「のぞみ」)と航空機(B777-200)を比較した場合、東京～大阪間を移動する際の1座席当たりのエネルギー消費量は約8分の1、CO₂排出量は約12分の1) High energy efficiency and low CO₂ emission Compared with an airplane (B777-200), the Tokaido Shinkansen (Series N700 "Nozomi") consumes approx. one-eighth of the amount of energy per passenger seat of air when traveling between Tokyo and Osaka, and discharges about one-twelfth of the CO₂ emissions of air travel.
快適 Comfort	<ul style="list-style-type: none"> 広い車内空間、静かな車内 Spacious interior and quiet ride

最速列車の所要時間の変遷(東京～新大阪) Historical Improvement of Travel Time between Tokyo and Shin-Osaka (Based on the Fastest Shinkansen Train)

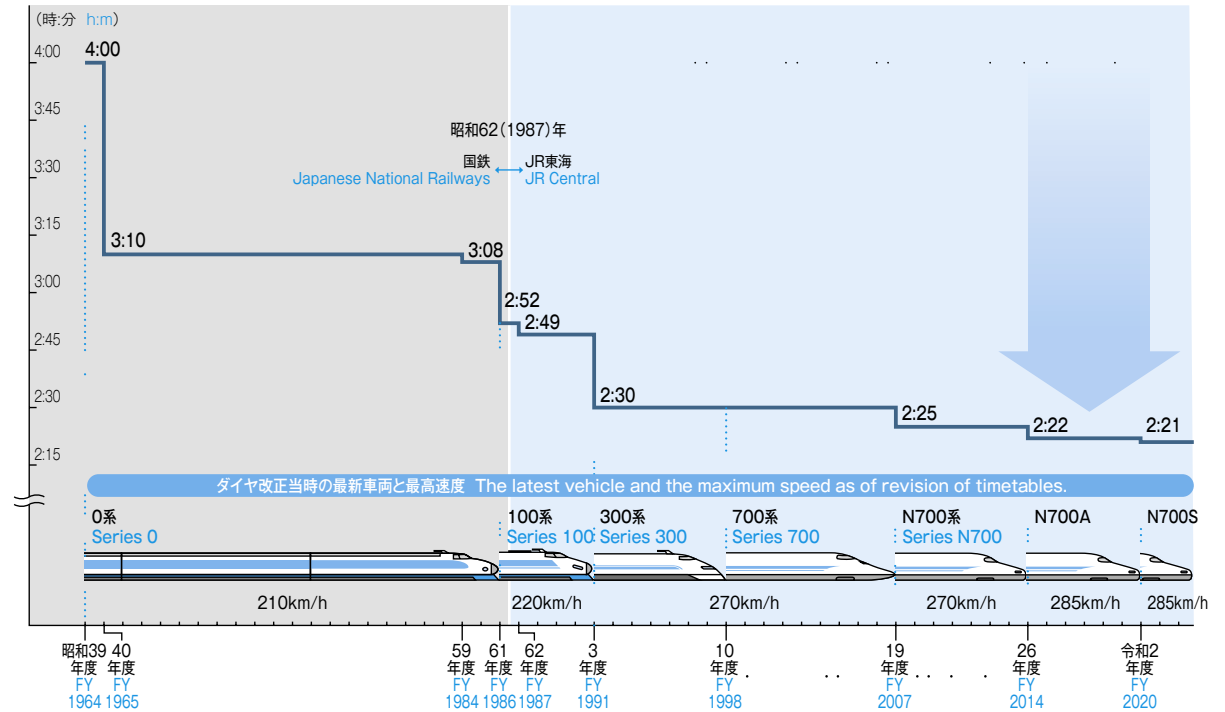

東海道新幹線の車種別電力消費量の比較 Comparison of Electric Power Consumption by Tokaido Shinkansen Rolling Stock Type

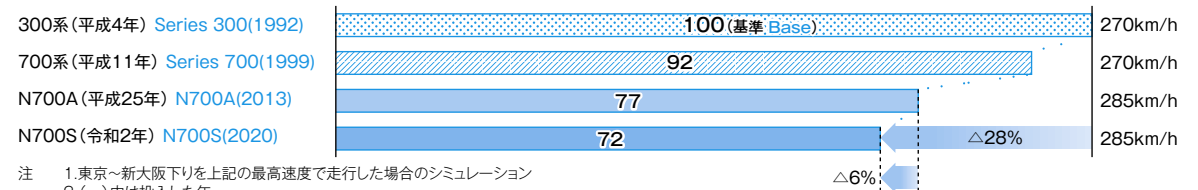

注 1.東京～新大阪下りを上記の最高速度で走行した場合のシミュレーション
2.()内は投入した年
Note: 1.Simulated run from Tokyo to Shin-Osaka at the maximum speeds identified above.
2.Years in parenthesis indicate introduction year of each rolling stock.

東京～大阪間の運行におけるCO₂排出量の比較(1座席当たり) Comparison of CO₂ Emissions from operation between Tokyo and Osaka (per seat)

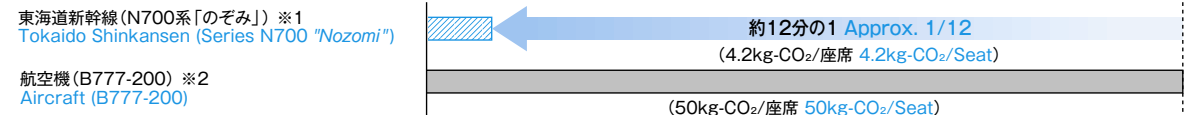

注 1.走行実績(当社分)に基づく算出 N700系「のぞみ」(東京～新大阪)
2.ANA「アニュアルレポート 2011」を参考に当社算出 B777-200(羽田～伊丹・関西)
Note: 1.Calculated by JR Central based on running performance Series N700 "Nozomi" between Tokyo and Shin-Osaka.
2.Calculated by JR Central while referencing ANA "Annual Report 2011" B777-200 between Haneda and Osaka (Itami and Kansai).

東海道新幹線の輸送力強化及び営業施策の主な取組み Example of Strengthening Transportation Service and Sales, Campaign and Other Customer Service of the Tokaido Shinkansen Service

輸送力強化関連 Strengthening transportation service	年 Year	営業施策 Sales, campaign and other customer service
東海道新幹線「品川新駅」構想を発表 Launched the construction plan of "Shinagawa New Station".	平成2年 1990	
「のぞみ(300系)」の営業運転を開始、営業運転時の最高速度270kmを実現 "Nozomi" (the Series 300) began commercial operation. The maximum speed of 270 km/h was achieved in commercial operation.	平成4年 1992	
「のぞみ」の1時間1本運転を開始 "Nozomi" began operating at an interval of one train per every one hour.	平成5年 1993	「そうだ 京都、行こう。」キャンペーン開始 "Kyoto Campaign" started, targeting tourists.
700系の営業運転を開始 The Series 700 began commercial operation.	平成11年 1999	
「のぞみ」の30分間隔運転を開始 "Nozomi" began operating at 30 minute intervals.	平成13年 2001	東海道新幹線で「エクスプレス予約」サービス開始 "Express Reservation" (online reservation service) was launched for Tokaido Shinkansen.
東海道新幹線品川駅開業 The Shinagawa Shinkansen Station opened. 東海道新幹線の全列車の最高速度を270km/h化 The maximum speed of 270km/h for all Tokaido Shinkansen trainsets was attained. 抜本的なダイヤ改正(1時間当たり最大で「のぞみ」7本) A drastic timetable revision was implemented (maximum seven "Nozomi" hourly departures).	平成15年 2003	50歳からの旅クラブ「50+(フィフティ・プラス)」発足 A membership-based travelers' service "50+ (fifty plus)" was launched.
1時間当たり最大で「のぞみ」8本のダイヤ改正 Maximum eight "Nozomi" hourly departures.	平成17年 2005	「トーキョーブックマーク」キャンペーン開始 "Tokyo Bookmark Campaign" started. 「うまし うるわし 奈良」キャンペーン開始 "Nara Campaign" started.
東海道・山陽新幹線を直通する「のぞみ」の利便性をさらに向上するダイヤ改正 A timetable revision was implemented (further improving the convenience of "Nozomi" that operates between Tokaido and Sanyo sections).	平成18年 2006	「エクスプレス予約」サービスを山陽新幹線に拡大 "Express Reservation" was expanded to Sanyo Shinkansen (JR West line).
N700系の営業運転を開始 The Series N700 began commercial operation. N700系80編成集中投入(平成19(2007)~23(2011)年度) Introduced 80 sets of N700 trains (FY2007 - FY2011)	平成19年 2007	
全ての「のぞみ」「ひかり」を品川・新横浜に停車 All "Nozomi" and "Hikari" services stop at both Shinagawa and Shin-Yokohama Stations.	平成20年 2008	東海道新幹線でチケットレス乗車サービス「EX-IC」開始 "EX-IC" (ticketless boarding service) was launched for Tokaido Shinkansen.
1時間当たり最大で「のぞみ」9本のダイヤ改正 Maximum nine "Nozomi" hourly departures.	平成21年 2009	「EX-IC」サービスを山陽新幹線に拡大するとともに法人会員へのサービス提供開始 "EX-IC" was expanded to Sanyo Shinkansen and began to cover corporate members.
東海道・山陽新幹線を直通する全ての定期「のぞみ」をN700系で運転 All regular "Nozomi" with direct services to the Sanyo Shinkansen started to be operated by the Series N700.	平成22年 2010	
	平成23年 2011	訪日観光パッケージブランド「FLEX JAPAN」の展開開始 "FLEX JAPAN" (travel product brand for foreign visitors) was launched.
全ての定期「のぞみ」をN700系で運転 All regular "Nozomi" started to be operated by the Series N700.	平成24年 2012	東海道新幹線で「プラスEX」サービス開始 "PLUS EX" (simplified version of "Express Reservation") was launched for Tokaido Shinkansen.
N700Aの営業運転を開始 N700A began commercial operation 新大阪駅27番線及び引上線の使用開始 Started using the additional platform and draw-out tracks in Shin-Osaka Station.	平成25年 2013	
ほぼ全ての時間帯で1時間当たり最大で「のぞみ」10本のダイヤ改正 Maximum ten "Nozomi" hourly departures almost every hour.	平成26年 2014	東海道新幹線沿線への観光誘客を目的とした「Japan Highlights Travel」キャンペーン開始 "Japan Highlights Travel Campaign" (aiming to attract tourists to the areas along the Tokaido Shinkansen line) started.
最高速度285km/hへの速度向上 Increased Tokaido Shinkansen's maximum speed from 270km/h to 285km/h.	平成27年 2015	
全ての定期「のぞみ」「ひかり」をN700Aタイプの車両で運転 All regular "Nozomi" and "Hikari" started to be operated by the N700A type rolling stock.	平成29年 2017	東海道・山陽新幹線で「スマートEX」サービス開始 "smartEX" (the convenient online reservation service provided with easy navigation) was launched.
当社保有の全ての車両が最高速度285km/hで走行可能なN700Aタイプに統一 All rolling stock of the Company will be the N700A type and standardized to the maximum speed of 285km/h. 1時間当たり最大で「のぞみ」12本のダイヤ改正 Maximum twelve "Nozomi" hourly departures. N700Sの営業運転を開始 N700S began commercial operation.	令和2年 2020	

工事の概要 Summary of the Renovation Work

昭和39(1964)年に開業した東海道新幹線の経年劣化に対し、より長期にわたってその機能を維持するための改修工事

大規模改修に備え平成14(2002)年から引当金※1を積立て、平成25(2013)年度から工事に着手

注 1.全国新幹線鉄道整備法に基づく新幹線鉄道大規模改修引当金積立計画を策定し、国土交通大臣の承認を受け、平成14(2002)年から引当金を積立て

With its inauguration in 1964, the Tokaido Shinkansen is aging and requires renovation work to maintain its function well into the future.

JR Central reserved the allowance※1 since 2002, and started the large-scale renovation work in FY2013.

Notes: 1. Formulated the allowance reserve plan for the large-scale renovation of the Shinkansen infrastructure based on the Nationwide Shinkansen Railway Development Act and had reserved the allowance since 2002 with the approval by the Minister of Land, Infrastructure, Transport and Tourism.

大規模改修引当金の枠組み Framework of the Large-scale Renovation Allowance



大規模改修工事・設備投資額実績 Capital Investment of the Large-scale Renovation

	平成25年度 FY2013	26年度 FY2014	27年度 FY2015	28年度 FY2016	29年度 FY2017	30年度 FY2018	令和元年度 FY2019	2年度(予定) FY2020(Planned)
設備投資額 Related Capital Investment	9.5	30.2	35.5	34.0	36.3	36.1	37.0	40.0
うち営業費計上分 Of which amount posted to Operating Expenses	6.9	19.5	24.1	23.3	24.6	24.9	25.9	27.1

注 2.令和元(2019)~令和4(2022)年度 設備投資額1,360億円(予定) Notes: 2.FY2019 - FY2022 Related Capital Investment 136.0 billion yen (planned)

工事の実施方法 Content of Renovation Work

対象構造物 Target Facilities

「鋼橋」、「コンクリート橋」、「トンネル」の3種類
Steel Bridges, Concrete Viaducts and Bridges, and Tunnels

工事の種別 Content of Work

1 変状発生抑止対策 Measures to Inhibit Aging Damage

ひび割れ等の変状の発生自体を抑止
Inhibit the very occurrence of aging damage, such as cracks, of civil engineering structures.
構造物の健全性を維持し、延命化を実現
Maintain the soundness of civil engineering structures and extend their life.

2 全般的改修 Overall Renovation

部材そのものの取替え等を実施 ※3
Conduct renovation such as replacement of materials, etc. ※3

注 3.具体的な施工時期は、「変状発生抑止対策」を施工後構造物の状態を観察し、個別に判断

Notes: 3.The specific time of commencement will be separately determined taking into consideration the state of the structures after the implementation of the Measures to Inhibit Aging Damage.

大規模改修工事の主な内容 Concrete Example of Renovation Work

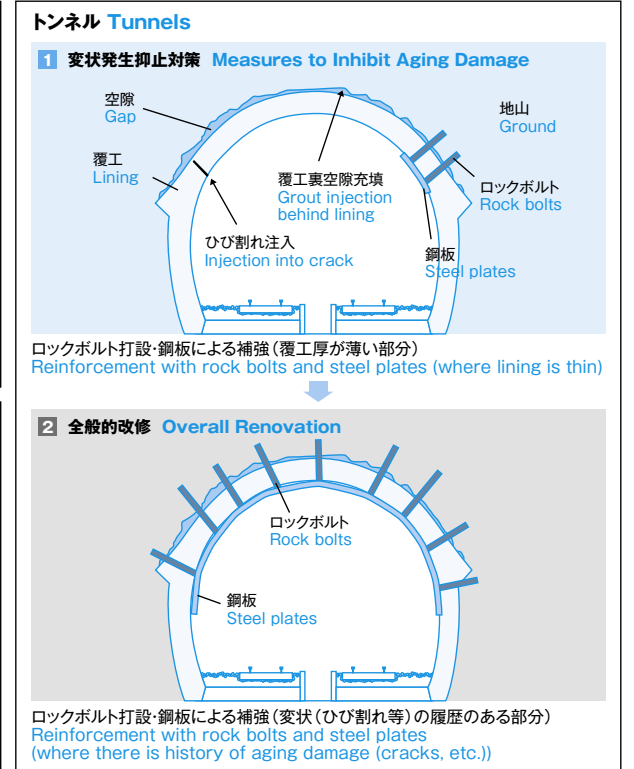
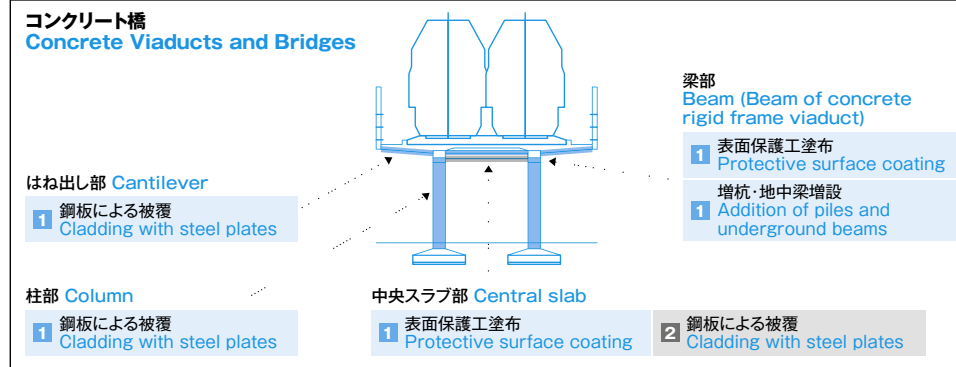
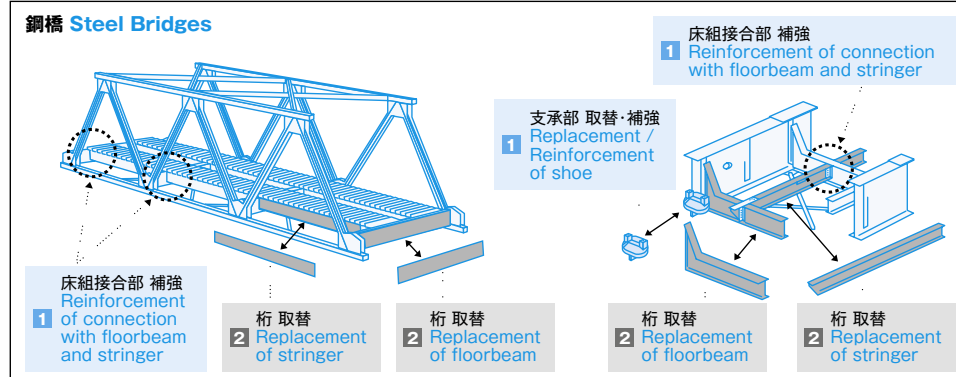

在来線の状況 Conventional Lines

在来線の列車本数および利用状況(1日当たり) Daily Departures and Passenger Volume for Conventional Lines

普通列車 Local Trains

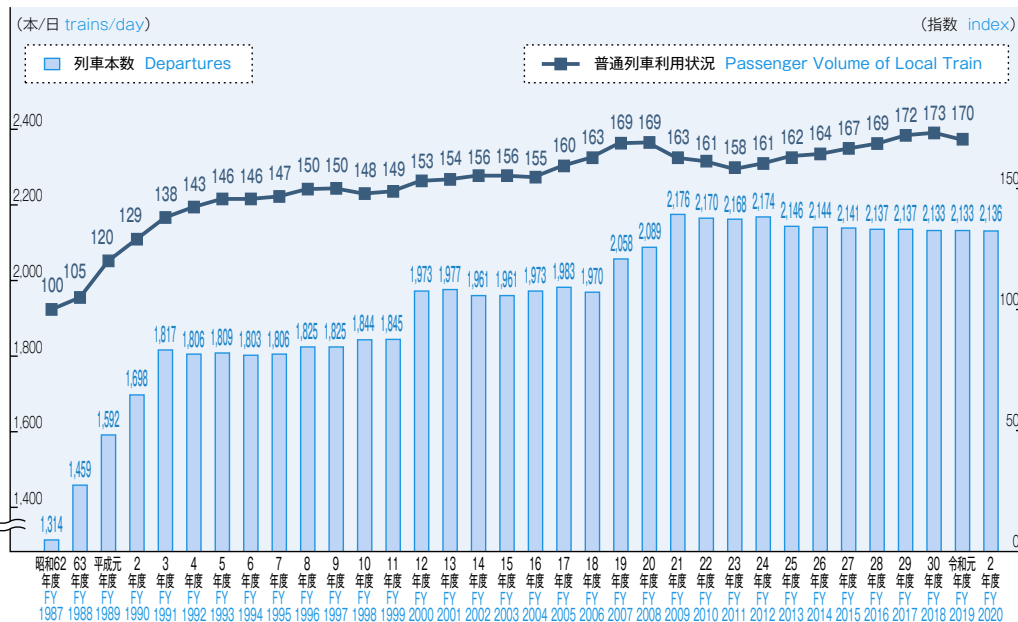

特急列車等 Express Trains

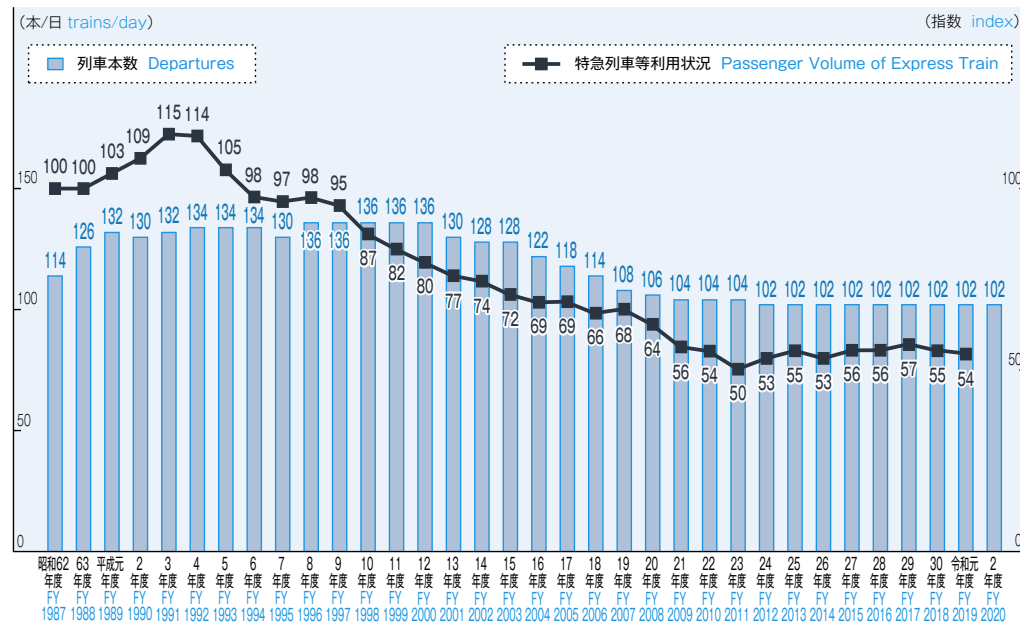

注 列車本数は各年度初の設定本数(臨時列車を除く)。利用状況は断面輸送量について昭和62(1987)年度を100とした場合の指数(普通列車の利用状況については、平成24(2012)年度以降は、自動改札集計による乗員人員合計を補正した指数)
 Note: Departures shown are as of the beginning of each fiscal year (excluding extra trains). Passenger volumes are the indices of the total passenger volume at certain points.
 FY1987=100 (Passenger Volume of Local Train from FY2012 are based on the passenger ridership counted by automatic ticket gates and are revised indices)

踏切の障害事故の推移 Number of Railroad Crossing Accidents

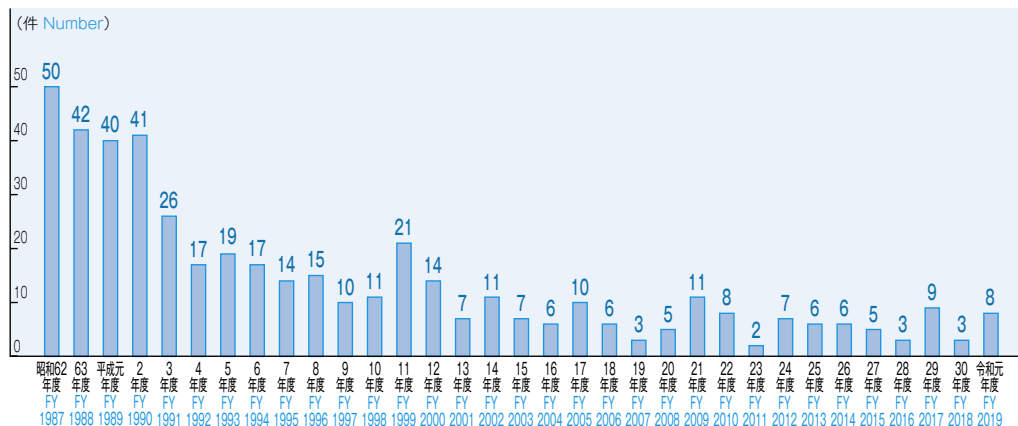

注 踏切の廃止、遮断機および警報機のある踏切への改良等の踏切事故防止対策の推進により、踏切障害事故の件数は会社発足時と比較して大幅に減少しています。
 Note: The number of railroad crossing accidents has decreased significantly compared to when the company was established, due to the promotion of prevention measures such as reduction of railroad crossings and improvement to crossings with gates and alarms.

在来線(電車・気動車)の電力・軽油消費量の比較 Comparison of Electricity Consumption and Diesel Fuel Consumption of Conventional Line Cars (Electric Cars and Diesel Railcars)

電車 Electric Cars

- 従来型(117系 110km/h) Conventional rolling stock (Series 117 110km/h)
- 省エネ型(211系 120km/h) New energy-saving type rolling stock (Series 211 120km/h)
- 省エネ型(313系 120km/h) New energy-saving type rolling stock (Series 313 120km/h)
- 省エネ型(315系 120km/h) New energy-saving type rolling stock (Series 315 120km/h)

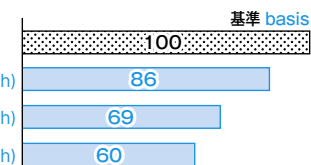

注 豊橋~大垣(快速運用)を走行した場合のシミュレーション
 Note: Based on simulated test runs between Toyohashi and Ogaki (rapid operation).

気動車 Diesel Railcars

- 従来型(従来エンジン搭載車) Conventional rolling stock (with conventional engine)
- 省エネ型(新型エンジン搭載車) New energy-saving type rolling stock (with new model engine)

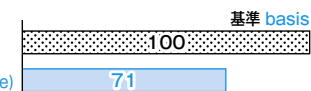

注 同一車両に新旧エンジンを搭載して走行した場合の実績による(従来エンジン:DMF 15HS型、新型エンジン:C-DMF 14HZ型)
 Note: Based on results of running the same railcar with conventional engine and new model engine (Conventional engine: DMF 15HS, new engine: C-DMF 14HZ).

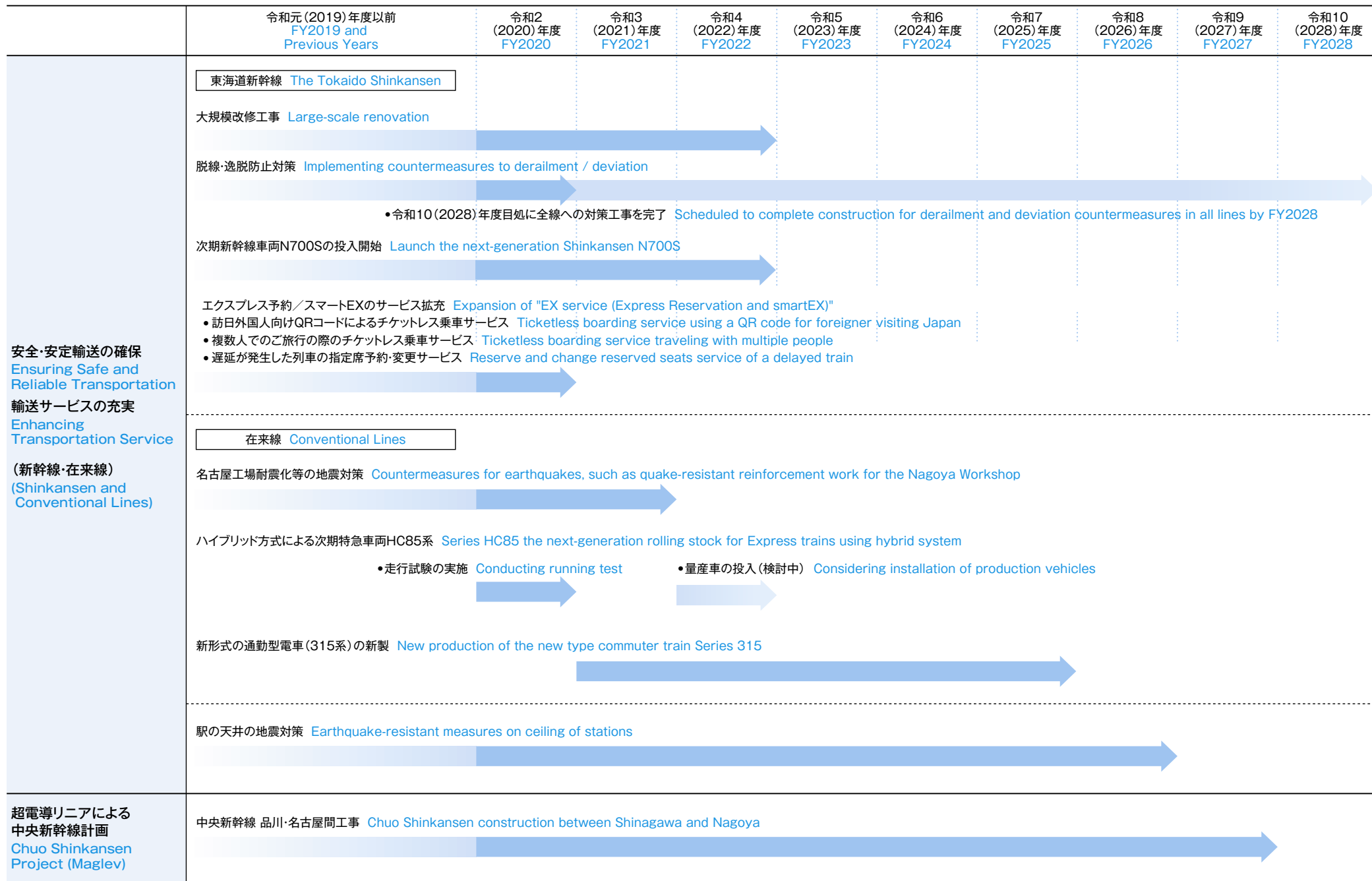

主な施策の展望 Future Expectation of Key Measures

超電導リニアによる中央新幹線計画 The Chuo Shinkansen Project Using the Superconducting Maglev

当社は、自らの使命であり経営の生命線である首都圏～中京圏～近畿圏を結ぶ高速鉄道の運営を持続するとともに、企業としての存立基盤を将来にわたり確保していくため、自己負担を前提に、超電導リニアによる中央新幹線計画を全国新幹線鉄道整備法に基づき進めています。

超電導リニア技術は、国土交通省の超電導磁気浮上式鉄道実用技術評価委員会より、「営業線に必要な技術開発は完了」と評価されています。

Under the condition that we bear all the construction cost, we are promoting the Chuo Shinkansen Project using the Superconducting Maglev system based on the Nationwide Shinkansen Railway Development Act to continually carry out our mission of operation of high-speed railway linking the Tokyo Metropolitan area, Chukyo region, and Kinki region, and to ensure the future foundation of the company.

The Superconducting Magnetic Levitation Technological Practicality Evaluation Committee of the Ministry of Land, Infrastructure, Transport and Tourism acknowledged that "the technologies required for a commercial line have been fully developed."

計画の概要 Summary of the Project

1. 超電導リニアによる圧倒的な時間短縮効果で三大都市圏が1つの巨大都市圏となり、経済・社会活動が活性化

1. The overwhelming time-reduction effect of the Chuo Shinkansen will merge the three main regions into a "Super Mega Region", energizing economic and social activity.

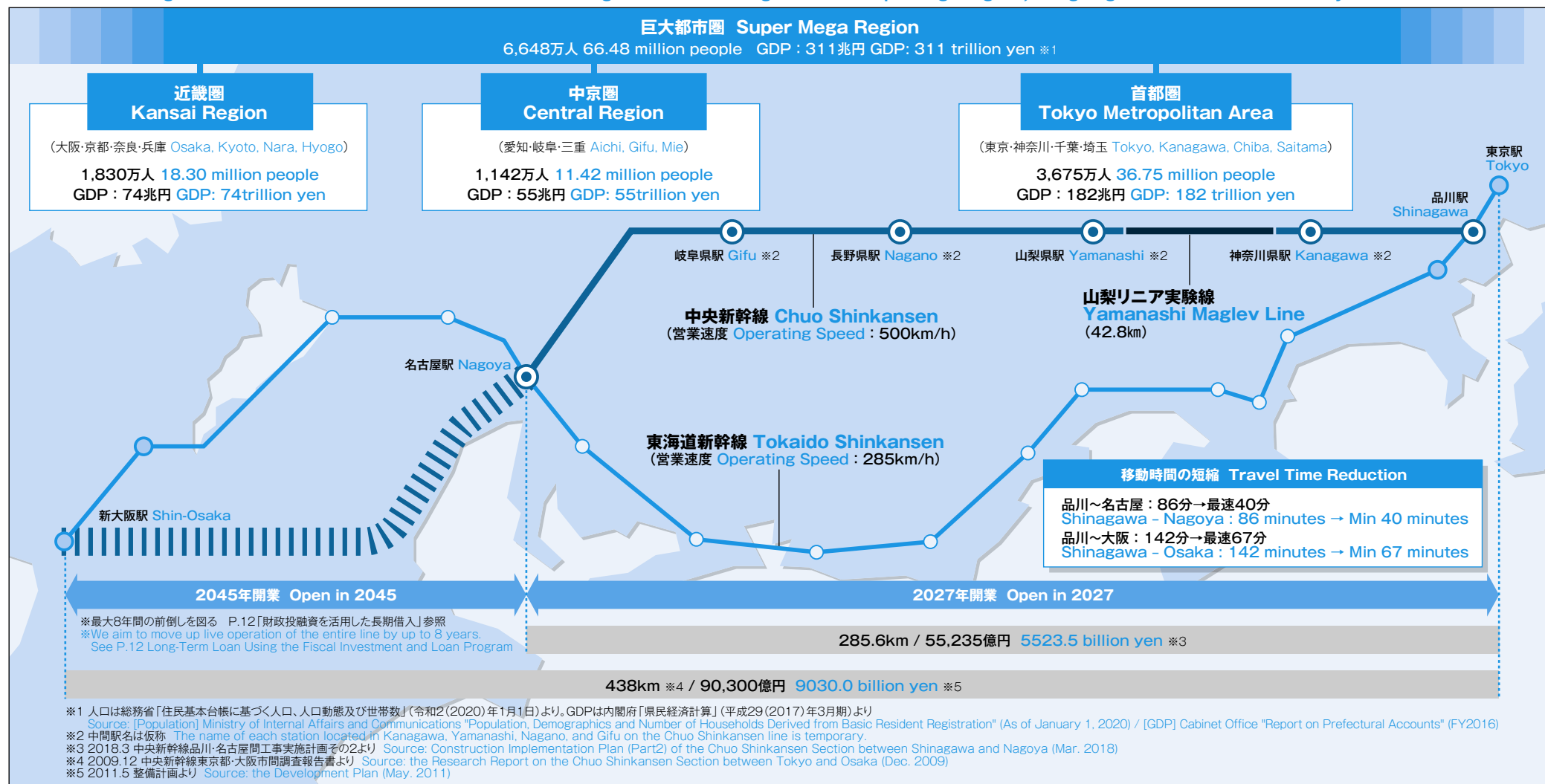

2. 超電導リニアによる中央新幹線の実現により、東京・名古屋・大阪の日本の大動脈輸送の二重系化を実現し、将来のリスク発生に備える
- ・開業以来50年以上経過する東海道新幹線の経年劣化に備える
 - ・巨大地震等の大規模災害に対して抜本的な備えが必要

2. We will duplicate our artery transportation system linking Tokyo, Nagoya, and Osaka with the Chuo Shinkansen, thereby preparing for future risk.

- ・We prepare for aging of the Tokaido Shinkansen which has operated more than five decades.
- ・We require drastic countermeasures against large-scale natural disasters including heavy earthquakes.

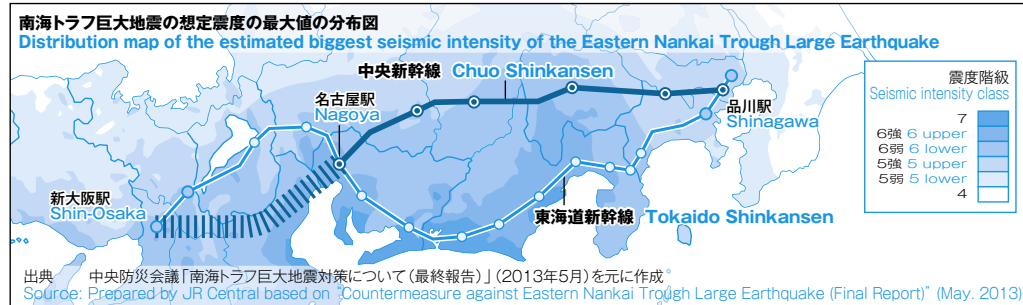

3. 東京～名古屋～大阪の直行輸送が相当程度中央新幹線に移ることで、東海道新幹線の活用可能性が広がる
3. Significant portion of "Nozomi" users will shift from the Tokaido Shinkansen to the Chuo Shinkansen, which enables more flexible use of the Tokaido Shinkansen.

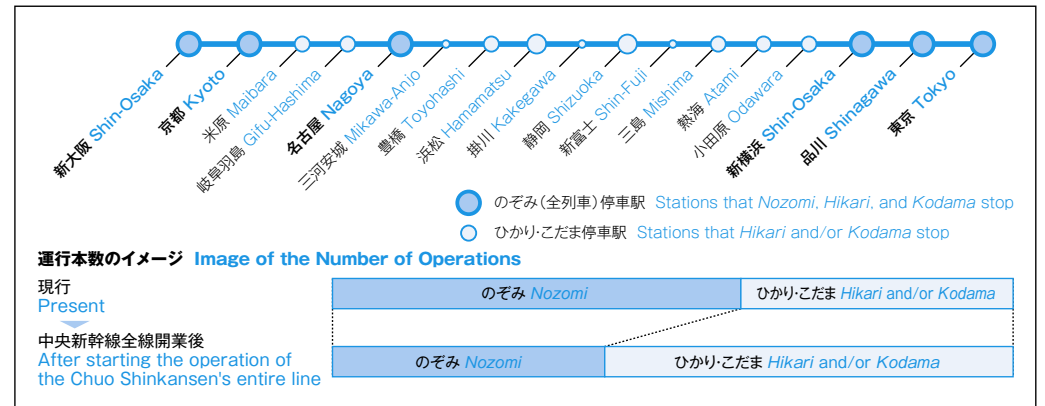

超電導リニアの安全性 The safety of Superconducting Maglev

地震時も脱線防止 Preventing derailment even in case of earthquakes

超電導リニアシステム※では、車両はガイドウェイに設置された浮上・案内コイルの作用(強固な磁気ばね)で支えられ、かつ常にガイドウェイ中央に安定して保持されるようになっているため脱線することはありません。

Thanks to the Superconducting Maglev system※ where railcars are always kept at the center of the guide way by magnetic power generated by levitation and guidance coils, they won't derail.

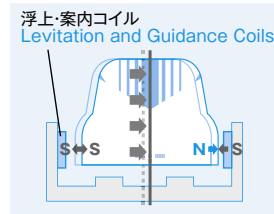

停電時も安全に停止 Safely stopping even in case of power outage

超電導リニアは、浮上のための電力を外部から供給する必要はありません。車両が一定以上の速度で走行していれば、浮上力が常に生じているため、停電時も車両は急に地面に落下することなく安全に停止します。

Superconducting Maglev can float without power supply from outside. While the cars run faster than a certain speed, levitation force continues to be generated. Therefore, in case of power outage, they can safely stop without falling onto the track.

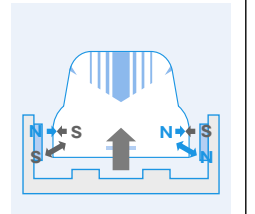

※ 超電導リニアの原理についてはこちらをご覧ください。 URL <https://linear-chuo-shinkansen.jr-central.co.jp/about/> ※ The principles of the Superconducting Maglev system can be found at the following URL. URL <https://scmaglev.jr-central-global.com/about/>

財政投融資を活用した長期借入 Long-Term Loan Using the Fiscal Investment and Loan Program (FILP)

中央新幹線の建設の推進のため、財政投融資を活用した長期借入の申請を独立行政法人鉄道建設・運輸施設整備支援機構に対して行い、総額3兆円の借入を2017年7月に完了しました。これによる当社のメリットは、右3つの経営リスクの低減です。

To promote the construction of the Chuo Shinkansen, we applied to Japan Railway Construction, Transport and Technology Agency for long-term loan Using the Fiscal Investment and Loan Program and borrowed 3 trillion yen in July 2017. The benefit is to mitigate following three managerial risks.

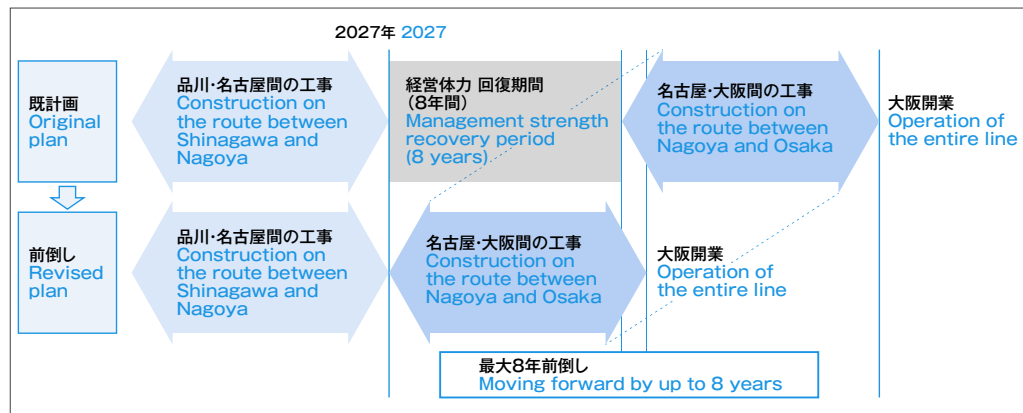

1. 金利上昇リスクの回避：平均利率は全期間固定の0.86%
2. 資金調達リスクの低減：品川・名古屋間の建設費約5.5兆円のうち新たに借入れが必要と見込まれる約3兆円を、今後の経済・金利変動の影響を受けることなく確保
3. 償還リスクの低減：中央新幹線の工事期間の後に財投借入の償還時期を迎えるため、全線開業後に得られる営業キャッシュフローを積み上げて債務の償還に備えることが可能に

1. Interest-rate increase risk : The weighted average rate is 0.86%, fixed throughout the entire period.
2. Financing risk : Under the original plan, roughly 3 trillion yen out of 5.5 trillion yen for construction cost for the route between Shinagawa and Nagoya, was expected to require new financing. However, we secured the amount through the FILP Loan, thanks to which we avoid being impacted by future fluctuation of economic conditions or interest rate.
3. Redemption Risk : Since the FILP Loan matures after the construction period of the Chuo Shinkansen, we will be able to build up cash from its full operation to provide for the redemption of liabilities.

2010年に国土交通省の交通政策審議会に提出した資料では、名古屋開業後に8年間、経営体力を回復するための期間を設け、長期債務を一定程度縮減した後、名古屋・大阪間の工事に着手する見通しとしていましたが、この財投借入の活用により、この経営体力の回復期間を短縮し、最大8年前倒しを目指して建設を推進します。なお、建設費を全額自己負担し民間企業としての経営の自由、投資の自主性を確保し、将来にわたり健全経営・安定配当を堅持するという前提は変わりません。

Under the original plan we submitted to the Transport Policy Council of the Ministry of Land, Infrastructure, Transport and Tourism in 2010, we indicated in our outlook that a period of 8 years after live operation between Shinagawa and Nagoya will be set to recover management strength. After reducing long-term debt by a certain amount, construction on the route between Nagoya and Osaka will be initiated. However, by utilizing this FILP Loan, we aim to reduce this period, thereby moving up live operation of the entire line by up to 8 years. This does not change the premise that we, as a private-sector corporation, cover all the construction cost, while securing autonomy in management and investment and seeing that sound management and stable dividends are strictly maintained also in the future.

JRセントラルタワーズとJRゲートタワー JR Central Towers and JR Gate Tower

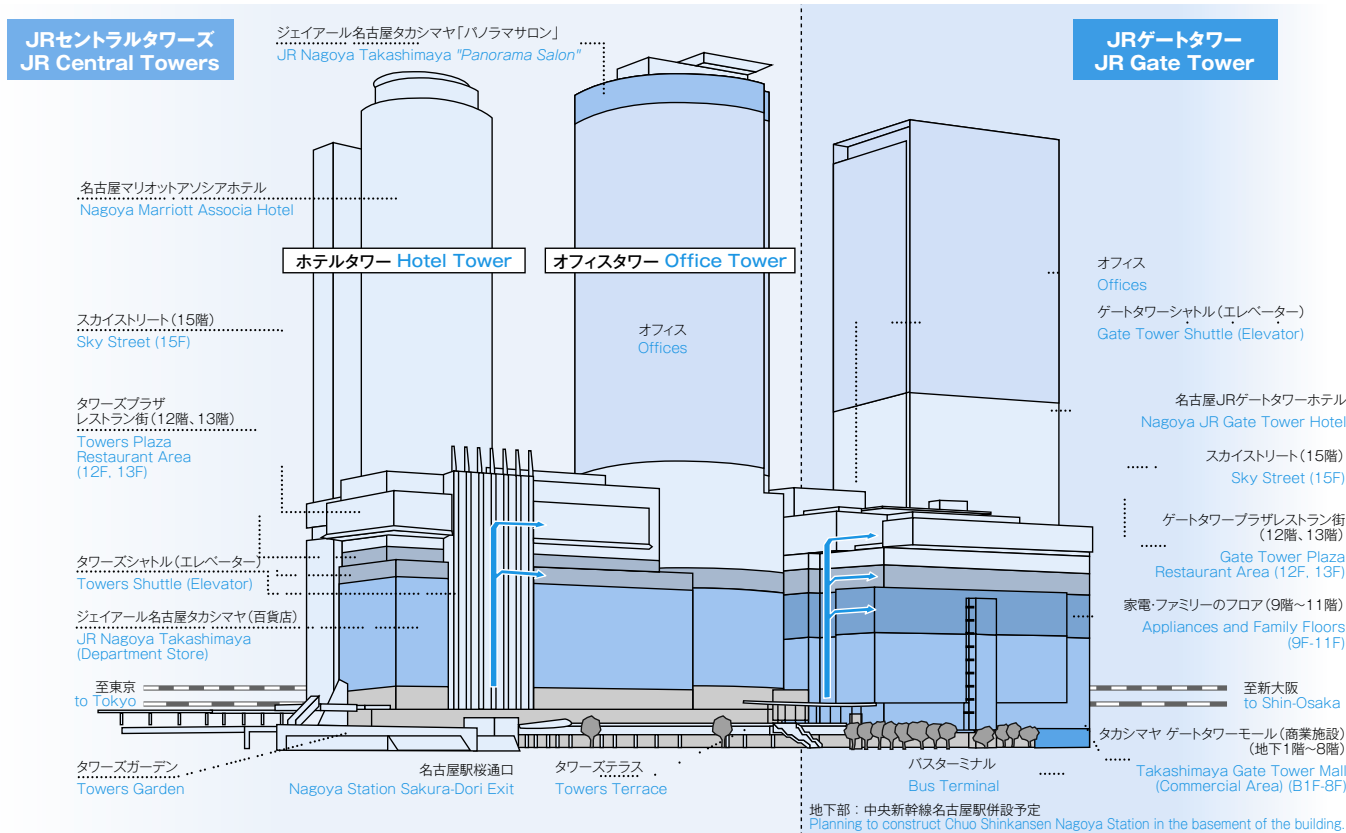

当社最大の駅である名古屋駅(平均乗車人員216千人/日)の開発は関連事業の柱
平成12(2000)年に駅の直上にJRセントラルタワーズを、平成29(2017)年には
タワーズに隣接してJRゲートタワーを全面開業

両ビルを一体的に運営し、双方の事業のコンセプトの明確な棲み分けによる相乗効果
の発揮や営業連携による収益拡大、そして効率的な運営による利益の最大化に取り
組む

Station Complex of Nagoya Station, with the most passengers
(216,000 passengers per day) in JR Central, forms a pillar of JR
Central affiliated businesses.

JR Central Towers opened in 2000, and JR Gate Tower opened in
2017 adjacent to JR Central Towers.

We aim integrated management of each building, through utilizing
synergy effect by identification of brand concepts, growing sales by
cooperation and collaboration, and pursuing the maximization of profit
by efficient operation.

連結子会社による主な事業 Main Businesses Operated by Consolidated Subsidiaries

	JRセントラルタワーズ JR Central Towers	JRゲートタワー JR Gate Tower
流通業 Merchandise	ジェイアール名古屋タカシマヤ JR Nagoya Takashimaya 	タカシマヤ ゲートタワーモール Takashimaya Gate Tower Mall
運営者 Operator	(株)ジェイアール東海高島屋 JR Tokai Takashimaya Co., Ltd	
不動産業 Real Estate	オフィス賃貸 Office Leasing	オフィス賃貸 Office Leasing
運営者 Operator	ジェイアールセントラルビル(株) JR CENTRAL BUILDING CO., LTD.	
ホテル業 Hotel	名古屋マリオットアソシアホテル Nagoya Marriott Associa Hotel 	名古屋JRゲートタワーホテル Nagoya JR Gate Tower Hotel
運営者 Operator	(株)ジェイアール東海ホテルズ JR Tokai Hotels Co., Ltd.	

JRセントラルタワーズとJRゲートタワーの概要 Overview of JR Central Towers and JR Gate Tower

	単位 Unit	JRセントラルタワーズ JR Central Towers	JRゲートタワー JR Gate Tower
延床面積 Total Floor Area	m ²	約417,000 Approx. 417,000	約260,000 Approx. 260,000
オフィス(賃貸面積) Offices (Rental Office Area)	m ²	約60,000 Approx. 60,000	約44,000 Approx. 44,000
店舗面積 Store Area	m ²	百貨店 Department Store 約68,000 Approx. 68,000	商業施設 Commercial Area 約32,000 Approx. 32,000 ※店舗面積は通路等を含む Store Area includes passages, etc
ホテル(客室数) Hotel (Guest Rooms)	室 rooms	774	350
駐車場(駐車台数) Parking	台 cars	約1,500 Approx. 1,500	約300 Approx. 300
バスターミナル Bus Terminal		なし No	あり Yes
高さ Height	m	245	約220 Approx. 220
階数 Floors			
地上 Above-ground	階 Floors	53 (ホテルタワー Hotel Tower) 51 (オフィスタワー Office Tower)	46
地下 Subterranean Floors	階 Floors	4	6
着工 Commencement of Construction		平成6(1994)年8月 August 1994	平成24(2012)年10月 October 2012
竣工(ビル本体) Completion of Construction (Building Body)		平成11(1999)年12月 December 1999	平成29(2017)年2月 February 2017
全面開業 Full Open		平成12(2000)年5月 May 2000	平成29(2017)年4月 April 2017
総事業費 Total Investment	億円 ¥ billion	約2,000 Approx. 200	約1,050 Approx. 105

連結子会社営業収益の推移 Operating Revenues of Consolidated Subsidiaries

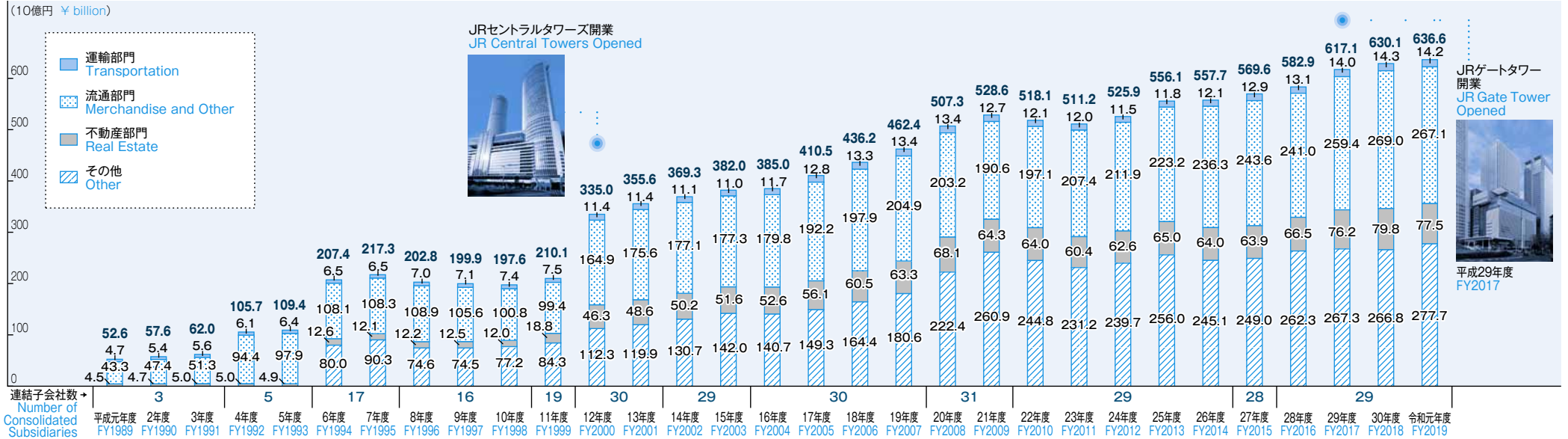

注 1. 連結子会社の営業収益の単純合算
2. 連結子会社数は各年度末時点

Notes: 1. Operating revenues of consolidated subsidiaries are simply aggregated.
2. The numbers of consolidated subsidiaries are as of the end of each fiscal year.

主な連結子会社一覧 JR Central's Main Consolidated Subsidiaries

(令和元(2019)年度末現在 As of the end of FY2019)

社名 Company	資本金(百万円) Capital (¥ million)	出資比率 Shareholding (%)	設立日 Date Established	主な事業内容 Main Business
運輸 Transportation				
ジェイアール東海バス(株) JR Tokai Bus Company	1,747	100.0	S63.3.1 March 1, 1988	バス事業 Bus transportation
流通 Merchandise and Other				
(株)ジェイアール東海高島屋 JR Tokai Takashimaya Co., Ltd.	10,000	59.2	H4.12.25 December 25, 1992	卸売・小売業(「JRセントラルタワーズ」内等での百貨店業等) Department store operations (JR Central Towers)
(株)ジェイアール東海パッセンジャーズ JR-CENTRAL PASSENGERS Co., Ltd.	998	100.0	S63.5.23 May 23, 1988	小売業及び飲食業(車内・駅構内の物品販売及び飲食店営業) Merchandise sales and Food service in stations and on trains
東海キヨスク(株) Tokai Kiosk Company	700	100.0	S62.6.5 June 5, 1987	卸売・小売業(駅構内の物品販売) Merchandise sales in stations
ジェイアール東海商事(株) JR Tokai Corporation	100	70.0	S63.3.1 March 1, 1988	卸売・小売業(燃料・建築資材・各種機械器具等の販売) Sales of fuel, construction materials, and various equipment
不動産 Real Estate				
ジェイアールセントラルビル(株) JR CENTRAL BUILDING CO., LTD.	45,000	100.0	H6.6.9 June 9, 1994	駅ビル営業(「JRセントラルタワーズ」等の管理・運営等) Station building management (JR Central Towers)
ジェイアール東海不動産(株) JR Tokai Real Estate Co., Ltd.	16,500	100.0	H13.3.27 March 27, 2001	不動産事業(不動産賃貸・販売業等) Real estate leasing and Sales
新横浜ステーション開発(株) Shin-Yokohama Station Development Co., Ltd.	9,304	100.0	S62.6.15 June 15, 1987	駅ビル営業(「新横浜中央ビル」の管理・運営等) Station building management
東京ステーション開発(株) Tokyo Station Development Co., Ltd.	1,750	100.0	H17.1.5 January 5, 2005	駅ビル営業(「東京駅一番街」の管理・運営等) Station building management
名古屋ステーション開発(株) Nagoya Station Area Development Corporation	480	100.0	S63.3.8 March 8, 1988	駅ビル営業(名古屋駅商業施設「アピオ」「チャム」等の管理・運営等) Station building management
ジェイアール東海関西開発(株) JR Development and Management Corporation of Kansai	30	100.0	S63.6.8 June 8, 1988	駅ビル営業(「アステイ京都」の管理・運営等) Station building management
その他 Other				
(株)ジェイアール東海ホテルズ JR Tokai Hotels Co., Ltd.	14,000	100.0	H4.7.8 July 8, 1992	ホテル業(「名古屋マリオットアソシアホテル」他) Hotel operations
(株)ジェイアール東海ツアーズ JR Tokai Tours	490	70.0	H1.12.18 December 18, 1989	旅行業 Travel service
(株)ジェイアール東海エージェンシー JR TOKAI AGENCY CO., LTD.	61	90.0	S38.11.8 November 8, 1963	広告業 Advertising
日本車輛製造(株) NIPPON SHARYO, LTD.	11,810	51.2	M29.9.18 September 18, 1896	鉄道車両等製造業 Manufacturing of railway rolling stock
ジェイアール東海建設(株) JR TOKAI CONSTRUCTION Co., Ltd.	300	100.0	S63.9.26 September 26, 1988	建設業 Construction
中央リネンサプライ(株) CHUO LINEN SUPPLY Co., Ltd.	150	87.6	S39.2.1 February 1, 1964	リネンサプライ業(列車内等でのリネン用品の供給) On-board linen supply
日本機械保線(株) The Japan Mechanised Works and Maintenance of Way Co. LTD	100	92.1	S42.3.3 March 3, 1967	新幹線軌道の機械保守 Maintenance and inspection of Shinkansen track
東海交通機械(株) Tokai Rolling Stock & Machinery Co., Ltd.	80	88.4	S51.3.4 March 4, 1976	車両・機械設備の検査・修繕 Machinery maintenance and inspection of rolling stock

連結子会社の状況 Consolidated Subsidiaries

単体決算の推移 Non-consolidated Financial Data

(10億円 ￥ billion)

■ 収支状況 Operating Results	昭和62年度	平成2年度			21年度	22年度	23年度	24年度	25年度	26年度	27年度	28年度	29年度	30年度	令和元年度
	FY1987	FY1990	FY1991	FY1992	FY2009	FY2010	FY2011	FY2012	FY2013	FY2014	FY2015	FY2016	FY2017	FY2018	FY2019
営業収益 Operating Revenues	874.6	1,101.3	1,130.7	1,110.5	1,143.9	1,171.9	1,184.5	1,245.0	1,277.2	1,306.6	1,357.9	1,380.7	1,427.4	1,464.8	1,436.9
鉄道事業収入 Railway Business	872.4	1,097.3	1,126.4	1,105.4	1,134.9	1,162.6	1,175.6	1,235.9	1,268.5	1,297.8	1,349.7	1,371.9	1,414.8	1,452.0	1,422.2
旅客運輸収入 Transportation Revenues	829.4	1,048.1	1,074.0	1,051.6	1,072.8	1,098.3	1,108.1	1,169.1	1,214.8	1,243.2	1,294.7	1,315.8	1,358.3	1,396.6	1,365.6
鉄道線路使用料収入 Railway Usage	2.1	2.4	2.5	2.8	4.6	4.2	4.1	4.2	4.2	4.2	4.3	4.2	4.1	3.9	4.2
運輸雑収 Miscellaneous	40.9	46.6	49.7	50.8	57.4	60.0	63.4	62.6	49.3	50.3	50.6	51.7	52.3	51.3	52.2
関連事業収入 Affiliated Business	2.1	4.0	4.3	5.1	9.0	9.2	8.9	9.0	8.6	8.7	8.2	8.8	12.5	12.8	14.7
営業費 Operating Expenses	803.1	968.1	843.1	705.8	869.8	846.4	839.0	845.9	816.3	831.1	800.3	784.9	802.1	797.1	813.9
人件費 Personnel Expenses	117.8	152.1	163.9	173.3	172.7	173.4	170.5	172.7	174.3	177.4	179.4	179.2	179.6	179.7	175.1
物件費 Non-Personnel Expenses	199.7	289.1	313.7	308.1	417.6	400.3	394.0	416.1	348.6	365.1	358.3	354.9	382.0	381.7	401.3
動力費 Energy	33.4	38.1	39.4	40.1	32.0	31.4	34.1	35.2	41.2	45.0	40.5	35.7	39.1	43.1	43.3
修繕費 Maintenance	73.7	104.8	133.6	126.5	177.4	173.6	178.7	196.1	125.1	136.6	131.9	134.6	145.4	140.5	156.1
業務費 Others	92.5	146.2	140.7	141.4	208.1	195.2	181.1	184.7	182.2	183.4	185.7	184.5	197.3	198.0	201.9
新幹線使用料 Shinkansen Leasing Fee	416.8	420.0	207.8	—	—	—	—	—	—	—	—	—	—	—	—
租税公課 Taxes Other Than Income Taxes	14.4	24.6	24.6	37.5	32.3	32.6	32.8	33.3	32.9	32.7	35.3	39.6	41.8	42.2	41.8
減価償却費 Depreciation and Amortization	54.2	82.1	132.8	186.7	247.0	240.0	241.4	223.7	260.3	255.8	227.0	210.9	198.6	193.4	195.5
営業利益 Operating Income	71.5	133.2	287.6	404.7	274.1	325.4	345.5	399.1	460.8	475.4	557.6	595.8	625.2	667.7	623.0
営業外損益 Non-Operating Income (Loss)	△10.7	△3.9	△170.5	△337.0	△125.7	△117.8	△105.7	△96.7	△89.0	△77.6	△67.1	△54.5	△77.6	△77.6	△83.0
営業外収益 Non-Operating Revenues	12.4	17.1	21.1	16.3	6.7	8.1	8.0	7.6	8.4	10.3	7.6	7.5	8.3	10.4	10.5
受取利息・配当金 Interest and Dividend Income	11.4	15.2	18.4	12.0	2.6	3.1	3.3	3.1	3.1	3.1	3.0	2.2	3.5	5.0	5.8
その他 Others	0.9	1.9	2.7	4.3	4.0	5.0	4.7	4.4	5.3	7.1	4.5	5.3	4.7	5.3	4.7
営業外費用 Non-Operating Expenses	23.2	21.1	191.7	353.3	132.4	126.0	113.7	104.3	97.5	88.0	74.7	62.0	85.9	88.0	93.6
支払利息 Interest Expenses	21.9	20.5	190.6	349.3	115.8	107.1	98.3	88.7	80.0	72.1	65.3	60.1	79.1	81.2	80.5
その他 Others	1.2	0.5	1.1	4.0	16.6	18.9	15.3	15.5	17.4	15.8	9.3	1.9	6.8	6.8	13.1
経常利益 Ordinary Income	60.7	129.2	117.0	67.6	148.3	207.5	239.8	302.4	371.8	397.7	490.5	541.2	547.6	590.1	540.0
特別損益 Extraordinary Income (Loss)	0.0	△12.0	0.2	0.1	△2.9	△0.7	△0.1	△0.5	△1.0	0.0	1.2	△0.1	1.9	0.0	△0.0
特別利益 Extraordinary Income	11.1	2.4	3.1	1.2	7.2	20.9	3.0	7.8	1.9	4.0	6.5	2.6	12.6	4.0	2.5
特別損失 Extraordinary Loss	11.0	14.4	2.8	1.0	10.1	21.7	3.1	8.3	2.9	3.9	5.2	2.7	10.7	3.9	2.6
税引前当期純利益 Income before Income Taxes	60.8	117.2	117.3	67.8	145.4	206.7	239.7	301.8	370.7	397.8	491.7	541.1	549.5	590.1	539.9
法人税等 Income Taxes	44.2	63.9	60.9	34.4	66.4	87.1	98.3	123.4	130.2	125.6	155.7	151.7	172.9	179.7	164.1
法人税等調整額 Deferred Taxes	—	—	—	—	△9.3	△3.3	20.5	△9.4	0.1	11.9	7.3	7.5	△7.7	△3.5	△3.0
当期純利益 Net Income	16.5	53.2	56.3	33.3	88.4	123.0	120.8	187.8	240.3	260.2	328.6	381.8	384.4	414.0	378.8

注 平成10(1998)年度から会計制度の変更により、事業税の計上箇所を営業費より法人税等に変更

Note: Due to a change in Japanese accounting standards, enterprise tax, which was recorded as an operating expense, is recorded as a part of income taxes from FY1998.

■ 財務状況 Financial Position

(10億円 ￥ billion)

資産合計 Total Assets	703.7	1,067.9	6,208.4	6,205.3	5,010.3	5,075.0	5,033.5	5,042.9	4,986.0	5,013.4	5,059.4	6,814.3	8,726.4	9,092.1	9,401.2
負債合計 Total Liabilities	521.7	730.6	5,831.6	5,806.5	3,953.6	3,918.9	3,775.3	3,606.5	3,324.7	3,082.3	2,839.5	4,231.5	5,796.5	5,776.6	5,742.6
長期債務 Long-Term Debt and Long-Term Payables	313.6	374.3	5,456.2	5,422.3	3,117.0	3,001.5	2,829.1	2,614.9	2,351.7	2,136.3	1,915.6	3,369.0	4,856.2	4,851.1	4,846.0
純資産合計 Total Equity	182.0	337.2	376.7	398.8	1,056.7	1,156.1	1,258.2	1,436.3	1,661.3	1,931.0	2,219.9	2,582.8	2,929.8	3,315.4	3,658.6

注 平成18(2006)年度から会計制度の変更により、「資本」表記を「純資産」表記に変更

Note: Due to a change in Japanese accounting standards, "Shareholders' equity" changed to "Equity" from FY2006.

■ 設備投資額 Capital Investment

(10億円 ￥ billion)

設備投資額 Capital Investment	50.1	174.3	197.8	211.1	244.8	288.8	298.4	301.6	229.0	257.2	259.1	330.8	384.5	448.8	499.6
安全関連投資額 Safety-related Investment	39.1	71.8	80.6	72.7	138.5	164.7	142.9	136.9	143.5	173.1	173.1	180.8	167.3	170.1	186.2
中央新幹線関連投資額 Chuo Shinkansen-related Investment	—	—	—	—	—	—	—	—	—	5.0	32.1	102.9	134.2	228.2	255.2

※ 平成3(1991)年10月に東海道新幹線に係る鉄道施設を譲り受け、その譲渡価額5兆956億円を鉄道施設購入長期未払金として計上 ※ Long-term accounts payable -railway facilities were incurred in the amount of ¥5,095.6 billion in October 1991 for the purchase of the facilities of the Tokaido Shinkansen.

注 記載が省略されている年度の数値は以下をご覧ください。
URL <https://company.jr-central.co.jp/ir/factsheets/>Note: The data of each year omitted here can be found at the URL below
URL <https://company.jr-central.co.jp/ir/factsheets/>

営業収益・営業利益・当期純利益の推移(単体) History of Operating Revenues, Operating Income, Earnings (Non-consolidated)

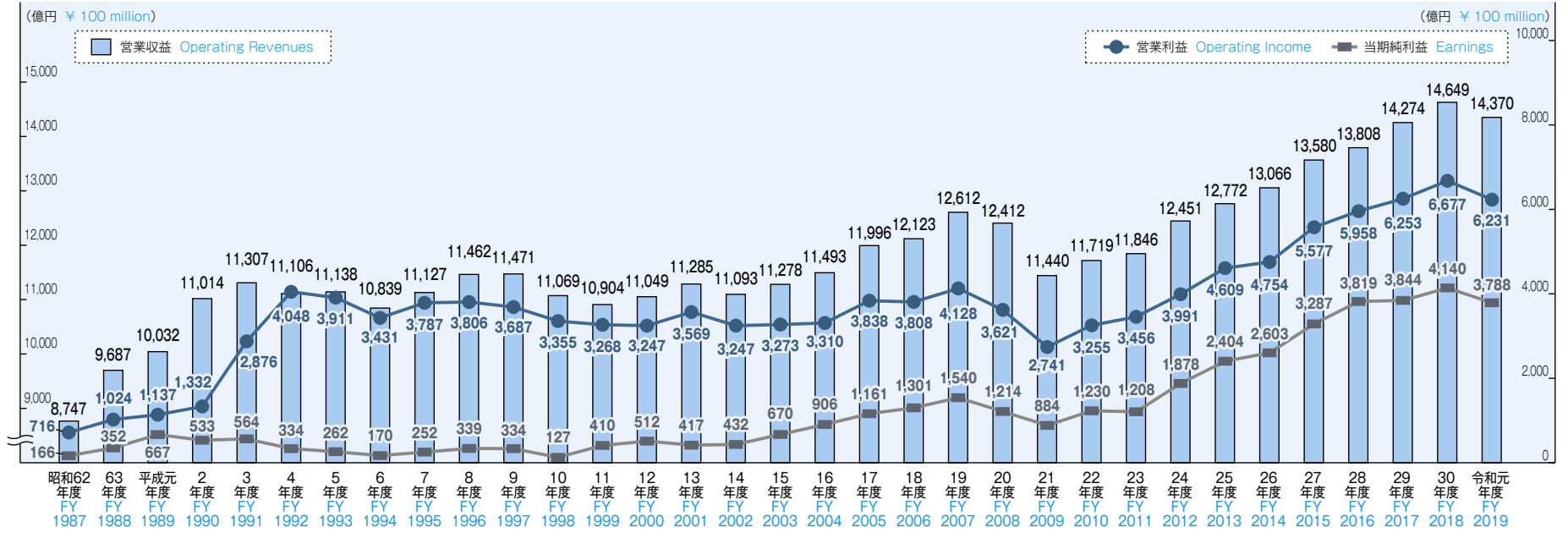

コスト構造の推移(単体) History of Cost Structure (Non-consolidated)

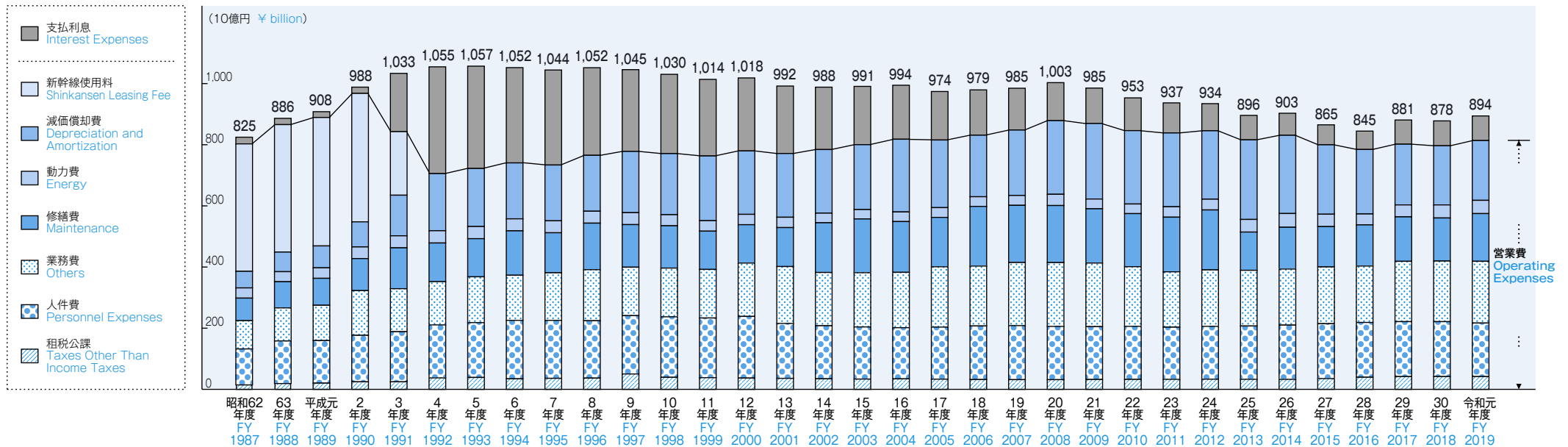

コスト構造(単体) Structure of Costs (Non-consolidated)

設備投資と配当(単体) Capital Investment and Dividend (Non-consolidated)

設備投資額の推移(単体) Historical Capital Investment (Non-consolidated)

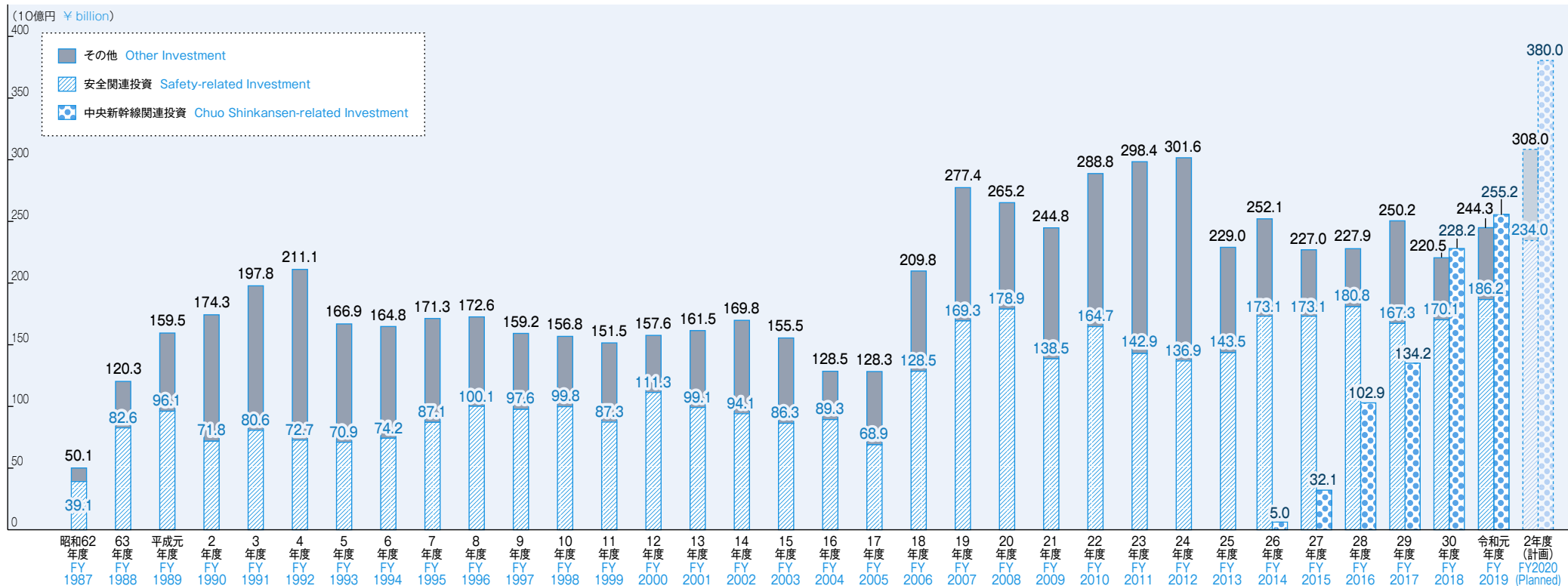

1株あたり配当額の推移 Historical Dividends Per Share

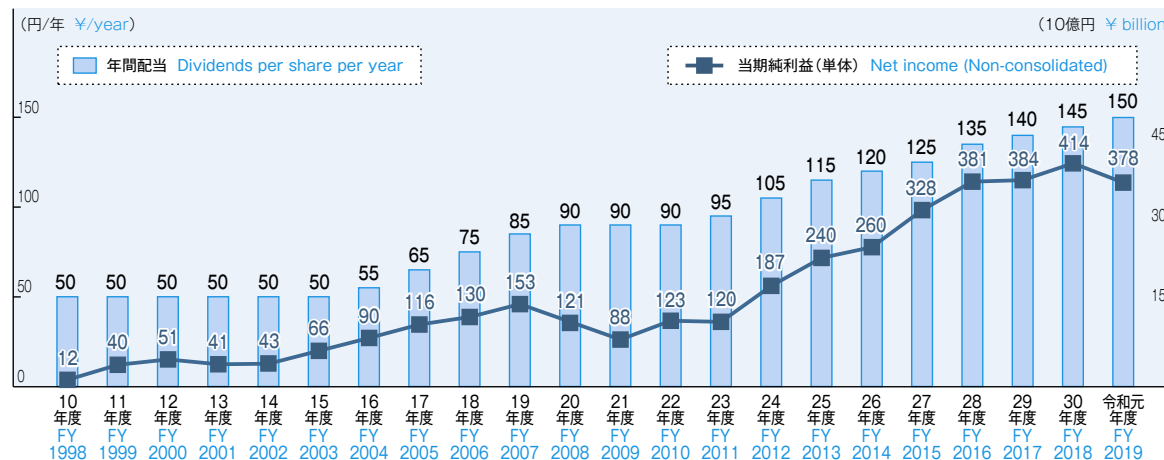

注 1.平成24(2012)年度の1株当たりの配当額については、平成24(2012)年10月1日を効力発生日として、普通株式1株を100株に分割し、1単元の株式の数を100株とする単元株制度を採用したことを受け、期首に当該株式分割が行われたと仮定して算定
 2.平成23(2011)年度以前の1株当たりの配当額については、平成24(2012)年度以降との比較を容易にするために100で除した値を表示
 Notes:1.As of the effective date, October 1, 2012, the Company split 1 share of common stock into 100 shares, and adopted a share unit system under which the number of shares constituting 1 unit is 100 shares. Therefore, the Company calculated dividends per share on the basis that such stock split was made at the beginning of the previous consolidated fiscal year and previous business year.
 2.The numbers of dividends per share before FY2011 are dividend by 100 to make easy comparison among the numbers of dividends per share after FY2012.

長期債務総額の推移(単体) Total Long-term Debt and Payables (Non-consolidated)

- 承継債務 Inherited Liabilities
- 社債 Corporate Bonds
- 長期借入金 Long-term Debt
- 鉄道施設購入長期未払金 Long-term Accounts Payable-railway Facilities
- 新幹線貸付制度下の実質的な債務 Latent Liabilities Born by the Shinkansen Leasing System
- 中央新幹線建設長期借入金 Long-term Debt for the Chuo Shinkansen Construction

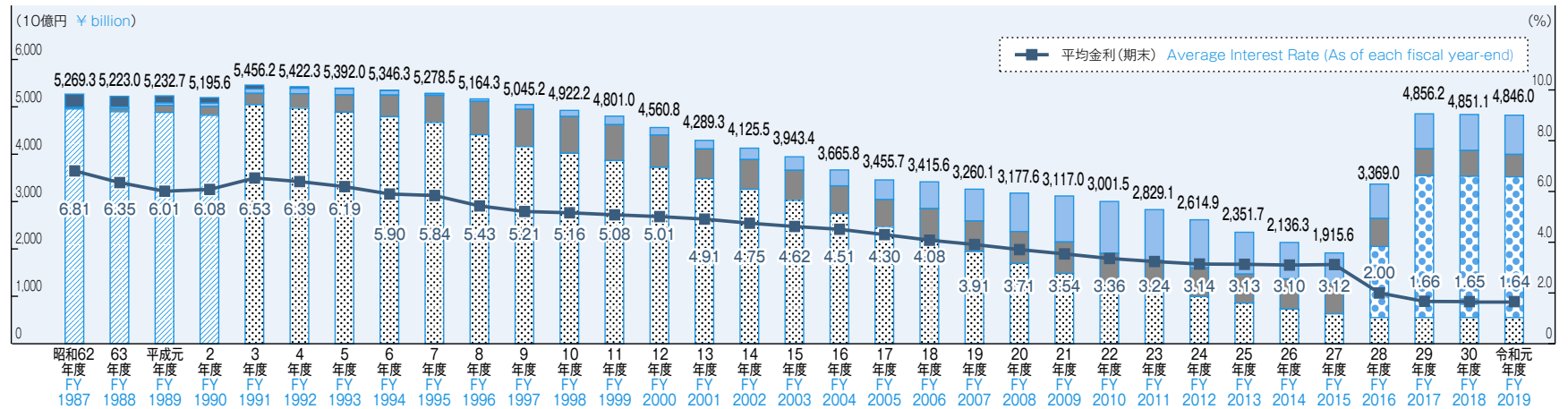

年度	昭和62年度	63年度	平成元年度	2年度	3年度	4年度	5年度	6年度	7年度	8年度	9年度	10年度	11年度	12年度	13年度	14年度	15年度	16年度	17年度	18年度	19年度	20年度	21年度	22年度	23年度	24年度	25年度	26年度	27年度	28年度	29年度	30年度	令和元年度
年度	1987	1988	1989	1990	1991	1992	1993	1994	1995	1996	1997	1998	1999	2000	2001	2002	2003	2004	2005	2006	2007	2008	2009	2010	2011	2012	2013	2014	2015	2016	2017	2018	2019
承継債務	278.8	222.8	146.4	112.4	79.9	32.1	6.6	3.4	1.2	-	-	-	-	-	-	-	-	-	-	-	-	-	-	-	-	-	-	-	-	-	-	-	-
社債	18.8	38.4	57.2	77.0	95.3	115.3	135.3	96.9	38.3	50.0	100.0	130.0	180.0	160.0	180.0	240.0	285.0	335.0	415.0	564.9	669.8	809.8	969.8	1,093.5	1,073.0	1,016.1	882.9	767.3	646.1	724.2	734.2	773.2	848.7
長期借入金	16.0	64.1	147.4	184.9	239.6	307.5	367.0	457.4	573.2	706.7	786.6	774.7	757.9	681.8	625.9	628.9	635.4	584.7	584.5	646.6	644.3	674.6	665.4	620.9	612.3	604.1	612.8	639.2	637.9	590.9	572.8	533.9	458.7
鉄道施設購入長期未払金	-	-	-	-	5,041.2	4,967.2	4,882.9	4,788.3	4,665.7	4,407.5	4,158.5	4,017.5	3,863.0	3,718.9	3,483.4	3,256.6	3,023.0	2,746.1	2,456.2	2,204.0	1,945.8	1,693.0	1,481.6	1,287.0	1,143.7	994.7	855.8	729.6	631.5	553.8	549.0	543.8	538.4
小計	313.6	325.3	351.0	374.3	5,456.2	5,422.3	5,392.0	5,346.3	5,278.5	5,164.3	5,045.2	4,922.2	4,801.0	4,560.8	4,289.3	4,125.5	3,943.4	3,665.8	3,455.7	3,415.6	3,260.1	3,177.6	3,117.0	3,001.5	2,829.1	2,614.9	2,351.7	2,136.3	1,915.6	1,869.0	1,856.2	1,851.1	1,846.0
新幹線貸付制度下の実質的な債務	4,955.7	4,897.7	4,881.7	4,821.3	-	-	-	-	-	-	-	-	-	-	-	-	-	-	-	-	-	-	-	-	-	-	-	-	-	-	-	-	-
中央新幹線建設長期借入金	-	-	-	-	-	-	-	-	-	-	-	-	-	-	-	-	-	-	-	-	-	-	-	-	-	-	-	-	-	-	-	-	-
長期債務合計	5,269.3	5,223.0	5,232.7	5,195.6	5,456.2	5,422.3	5,392.0	5,346.3	5,278.5	5,164.3	5,045.2	4,922.2	4,801.0	4,560.8	4,289.3	4,125.5	3,943.4	3,665.8	3,455.7	3,415.6	3,260.1	3,177.6	3,117.0	3,001.5	2,829.1	2,614.9	2,351.7	2,136.3	1,915.6	3,369.0	4,856.2	4,851.1	4,846.0
資金調達額	34.8	67.7	102.1	58.1	75.8	92.7	85.5	98.7	126.3	178.0	147.5	40.0	105.0	-	73.0	99.5	82.0	123.6	170.0	321.8	209.1	247.4	288.3	235.9	174.7	184.0	189.6	259.6	195.6	1,640.2	1,595.2	94.5	116.6
債務増減額	△5.5	11.6	25.7	23.3	△21.3	△37.8	△31.3	△45.6	△67.7	△114.2	△119.0	△123.0	△121.1	△240.2	△271.4	△163.7	△182.0	△277.6	△210.0	△40.0	△155.5	△82.5	△60.6	△115.4	△172.4	△214.1	△263.2	△215.4	△220.6	1,453.4	1,487.1	△5.0	△5.0
支払利息	21.9	20.5	19.0	20.5	190.6	349.3	334.6	311.6	310.7	286.5	267.5	259.3	250.5	238.7	220.7	204.0	190.7	176.6	158.6	148.2	136.7	124.3	115.8	107.1	98.3	88.7	80.0	72.1	65.3	60.1	79.1	81.2	80.5

注 1. 昭和62(1987)~平成2(1990)年度の「債務増減額」の数値は「小計」の増減を示す
 2. 平成3(1991)~5(1993)年度の「長期債務合計」の増減と「債務増減額」の不一致は、「鉄道施設購入長期未払金」の増加(平成3(1991)年度:51,032億円、平成4(1992)年度:39億円、平成5(1993)年度:9億円)による
 Notes: 1. For FY1987 through FY1990, the "Change in Total Long-term Debt and Payables" is based on the amount in the "Subtotal" category.
 2. For FY1991 through FY1993, the "Change in Total Long-term Debt and Payables" is not equivalent to the difference from the previous term's "Total Long-term Debt and Payables" owing to increases in "Long-term Accounts Payable-railway Facilities" (¥5,103.2 billion in FY1991, ¥3.9 billion in FY1992, and ¥0.9 billion in FY1993).

新幹線債務の残高 Long-term Accounts Payable-railway Facilities

支払期間	支払方法	利率	平成3(1991)年10月1日	令和元年(2019)年度末残高
Payment Schedule	Payment Method	Interest Rate	October 1, 1991	Outstanding at the End of March 2020
1号 No.1 平成3(1991)年10月1日~平成29(2017)年3月31日 October 1, 1991 to March 31, 2017	元利均等半年賦支払 Interest and principal paid in equal installments, semiannually	変動 Floating 4.09%	3,447,268	-
2号 No.2 平成3(1991)年10月1日~平成29(2017)年3月31日 October 1, 1991 to March 31, 2017	固定 Fixed	6.35%	1,047,197	-
3号 No.3 平成3(1991)年10月1日~令和33(2051)年9月30日 October 1, 1991 to September 30, 2051	固定 Fixed	6.55%	601,195	533,411
合計 Total			5,095,661	533,411

独立行政法人鉄道建設・運輸施設整備支援機構からの長期借入 Long-Term Loan from the Japan Railway Construction, Transport and Technology Agency

	第1回 First	第2回 Second	第3回 Third	第4回 Fourth	第5回 Fifth
借入額 Amount	500.0	500.0	500.0	750.0	750.0
利率 Interest Rate	0.6%	0.8%	0.9%	0.9%	1.0%
借入実行日 Borrowing Date	平成28(2016)年11月29日 November 29, 2016	平成29(2017)年1月16日 January 16, 2017	平成29(2017)年3月10日 March 10, 2017	平成29(2017)年5月17日 May 17, 2017	平成29(2017)年7月12日 July 12, 2017
返済方法 Repayment Method	令和28(2046)年5月まで据置 Deferred up to May 2046	令和28(2046)年7月まで据置 Deferred up to July 2046	令和28(2046)年9月まで据置 Deferred up to September 2046	令和28(2046)年5月まで据置 Deferred up to May 2046	令和28(2046)年7月まで据置 Deferred up to July 2046
弁済期限 Maturity Date	令和37(2055)年11月29日 November 29, 2055	令和38(2056)年1月16日 January 16, 2056	令和38(2056)年3月10日 March 10, 2056	令和37(2055)年11月17日 November 17, 2055	令和38(2056)年1月12日 January 12, 2056
担保 Security	無担保 Unsecured				

長期債務(単体) Long-term Debt and Payables (Non-consolidated)

社員の状況(単体) Employees (Non-consolidated)

社員数の推移 Number of Employees

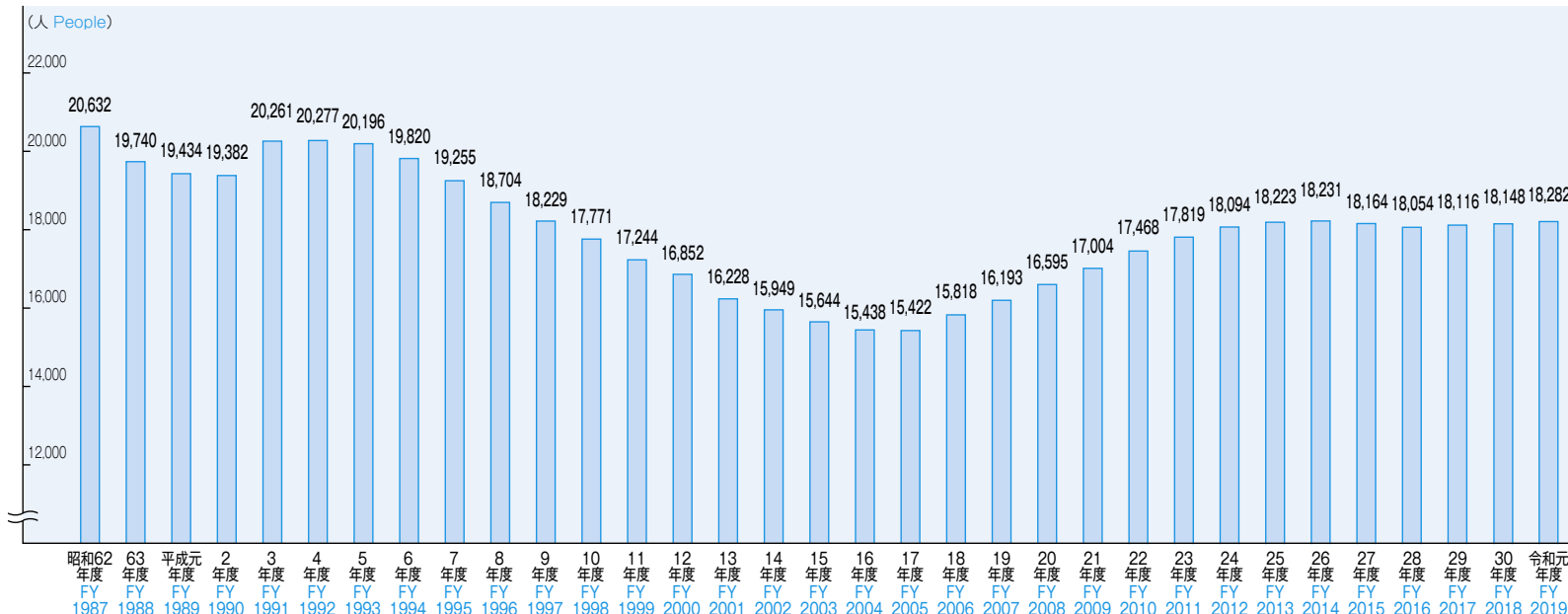

注 1.年度末時点の社員数(出向者等を除く)
2.昭和62(1987)年度初時点の社員数は21,410人

Notes: 1.Number of employees as of each fiscal year-end (excluding the number of employees seconded or otherwise assigned to other companies).
2.Number of employees at the beginning of FY1987 was 21,410.

社員の年齢構成 Employee Age Distribution

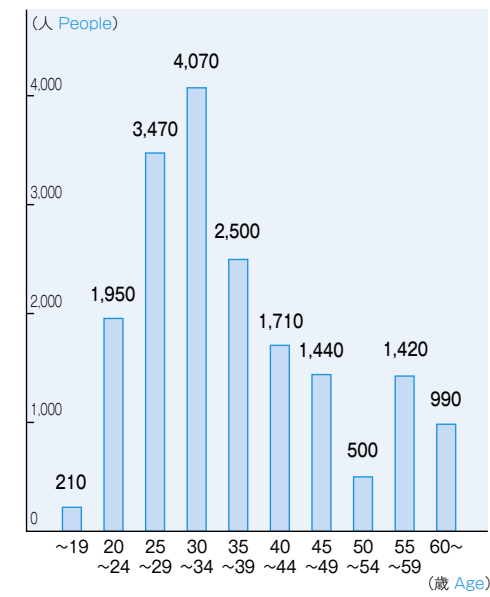

注 1.令和元(2019)年度末時点の社員数(出向者除く)
2.1の位を四捨五入

Notes: 1.Figures at the end of FY2019 (excluding the number of employees seconded or otherwise assigned to other companies).
2.Figures rounded to the nearest 10.

採用数 New Employees

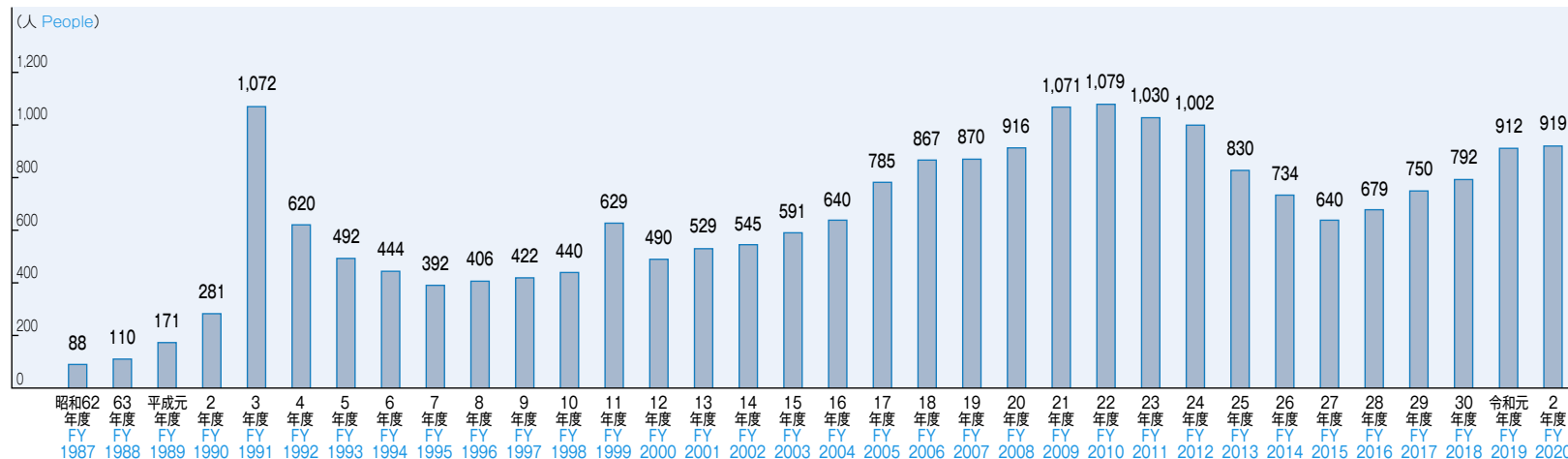

注 1.令和2(2020)年度は年度初の数字
2.平成3(1991)年度にそれまで停止していた新規採用(高校生)を再開
3.令和3(2021)年度の新規採用計画数(医療職除く)約870名

Notes: 1.The figure for FY2020 is the one at the beginning of the fiscal year
2.Recruitment of high-school graduates began in FY1991 for the first time since the establishment of the Company
3.The planned intake of new graduates in FY2021 is approx. 870 (excluding medical service personnel).

■ 旅客運輸収入 Transportation Revenues

			21年度 FY2009	22年度 FY2010	23年度 FY2011	24年度 FY2012	25年度 FY2013	26年度 FY2014	27年度 FY2015	28年度 FY2016	29年度 FY2017	30年度 FY2018	令和元年度 FY2019	
旅客運賃・料金 Transportation Revenues	東海道新幹線 Tokaido Shinkansen	定期 Commuter Passes	16.2	16.5	16.6	16.6	17.1	16.9	16.8	17.3	17.6	18.1	18.4	
		定期外 Others	957.3	983.0	994.4	1,053.0	1,096.7	1,126.5	1,175.2	1,194.5	1,235.5	1,273.6	1,242.9	
		計 Total	973.6	999.5	1,011.0	1,069.6	1,113.8	1,143.4	1,192.0	1,211.9	1,253.2	1,291.8	1,261.3	
	在来線 Conventional Lines	定期 Commuter Passes	33.9	34.1	34.0	34.0	34.3	34.0	33.9	34.8	35.1	35.2	35.2	35.4
		定期外 Others	65.2	64.5	62.9	65.3	66.6	65.7	68.7	69.1	69.9	69.5	68.8	
		計 Total	99.2	98.7	97.0	99.4	100.9	99.7	102.6	103.9	105.1	104.8	104.2	
	小計 Subtotal	定期 Commuter Passes	50.2	50.6	50.6	50.6	51.4	50.9	50.7	52.2	52.8	53.4	53.8	
		定期外 Others	1,022.5	1,047.6	1,057.4	1,118.4	1,163.3	1,192.2	1,243.9	1,263.6	1,305.5	1,343.2	1,311.7	
		計 Total	1,072.8	1,098.2	1,108.1	1,169.0	1,214.8	1,243.2	1,294.7	1,315.8	1,358.3	1,396.6	1,365.6	
小荷物運賃・料金 Parcel Fare			0.0	0.0	0.0	0.0	0.0	0.0	0.0	0.0	0.0	0.0	0.0	
合計 Total			1,072.8	1,098.3	1,108.1	1,169.1	1,214.8	1,243.2	1,294.7	1,315.8	1,358.3	1,396.6	1,365.6	

注 端数処理により、内訳の積算と合計が一致しない場合があります。 Note: The figures do not always equal the totals due to rounding.

■ 輸送人キロ Passenger-Kilometers

(100万人キロ million passenger-kilometers)

東海道新幹線 Tokaido Shinkansen	定期 Commuter Passes	1,355	1,375	1,389	1,391	1,444	1,390	1,431	1,450	1,479	1,519	1,542
	定期外 Others	41,330	42,366	42,915	45,540	47,429	48,744	50,734	51,459	53,277	54,758	52,467
	計 Total	42,685	43,741	44,303	46,930	48,873	50,134	52,166	52,909	54,756	56,277	54,009
在来線 Conventional Lines	定期 Commuter Passes	5,425	5,476	5,490	5,463	5,588	5,481	5,568	5,614	5,656	5,676	5,739
	定期外 Others	3,564	3,525	3,462	3,575	3,641	3,587	3,734	3,745	3,800	3,783	3,679
	計 Total	8,989	9,001	8,952	9,038	9,229	9,069	9,302	9,359	9,456	9,459	9,418
合計 Total	定期 Commuter Passes	6,779	6,851	6,879	6,854	7,032	6,871	6,999	7,064	7,135	7,196	7,281
	定期外 Others	44,895	45,891	46,377	49,114	51,070	52,332	54,468	55,205	57,076	58,541	56,146
	計 Total	51,674	52,742	53,255	55,968	58,102	59,203	61,467	62,269	64,212	65,736	63,427

■ 輸送人員 Passenger Ridership

(100万人 million passengers)

東海道新幹線 Tokaido Shinkansen	定期 Commuter Passes	14	14	14	14	15	14	15	15	15	15	16
	定期外 Others	124	127	129	135	140	143	148	150	155	159	152
	計 Total	138	141	143	149	155	157	163	165	170	174	168
在来線 Conventional Lines	定期 Commuter Passes	252	254	254	253	260	257	262	265	269	271	274
	定期外 Others	132	132	130	133	135	134	138	140	142	143	139
	計 Total	384	386	384	387	395	391	401	405	410	414	413
合計 Total	定期 Commuter Passes	264	266	266	266	273	269	275	278	281	284	287
	定期外 Others	247	249	249	259	265	267	276	279	286	291	281
	計 Total	511	515	516	524	538	536	551	557	567	574	568

注 輸送人員の合計は新幹線、在来線の重複人員を除いて計上 Note: A passenger using both Shinkansen and conventional lines in a single journey is counted as one ride in the Total rows.

■ 輸送効率 Transport Efficiency

(%)

東海道新幹線 Tokaido Shinkansen	55.6	58.0	59.1	62.2	63.5	63.6	64.3	63.9	65.5	66.4	62.7
在来線 Conventional Lines	32.8	32.7	32.3	32.7	32.9	32.4	32.8	32.4	32.7	32.5	32.2

注 輸送効率の算出方法は次の通り
新幹線座席利用率=旅客輸送人キロ/座席キロ(編成別列車キロ×座席数)×100
在来線乗車効率=旅客輸送人キロ/(客車走行キロ×平均定員)×100Note: Figures are calculated as below:
For Shinkansen: Passenger Kilometers / Available Seat Kilometers *100
For Conventional Lines: Passenger Kilometers / (Rolling Stock Kilometers * Average Passenger Capacity) *100注 記載が省略されている年度の数値は以下をご覧ください。
URL <https://company.jr-central.co.jp/ir/factsheets/>Note: The data of each year omitted here can be found at the URL below
URL <https://company.jr-central.co.jp/ir/factsheets/>

連結決算の推移 Consolidated Financial Data

(10億円 ¥ billion)

■ 収支状況 / 財務状況 Operating Results / Financial Position	平成元年度	2年度	3年度*1	4年度	11年度	12年度*2	21年度	22年度	23年度	24年度	25年度	26年度	27年度	28年度	29年度	30年度	令和元年度
	FY1989	FY1990	FY1991	FY1992	FY1999	FY2000	FY2009	FY2010	FY2011	FY2012	FY2013	FY2014	FY2015	FY2016	FY2017	FY2018	FY2019
営業収益 Operating Revenues	1,052.3	1,154.8	1,188.3	1,208.7	1,221.6	1,333.2	1,486.6	1,503.0	1,508.3	1,585.3	1,652.5	1,672.2	1,738.4	1,756.9	1,822.0	1,878.1	1,844.6
運輸業 Transportation	-	-	-	-	1,087.9	1,103.5	1,142.3	1,169.7	1,182.6	1,243.0	1,276.1	1,305.6	1,358.1	1,380.4	1,424.0	1,461.3	1,431.2
流通業 Merchandise and Other	-	-	-	-	98.3	163.3	188.6	195.0	205.2	209.5	220.7	233.8	239.6	237.0	255.3	264.9	263.2
不動産業 Real Estate	-	-	-	-	24.3	49.9	66.7	66.4	62.7	64.9	67.4	66.5	66.0	68.6	78.0	82.1	79.9
その他 Other	-	-	-	-	83.5	110.7	255.5	239.6	225.8	233.1	250.6	238.9	243.0	253.9	261.6	261.0	272.2
調整額 Reconciliations	-	-	-	-	△72.5	△94.3	△166.7	△167.7	△168.2	△165.5	△162.4	△172.8	△168.5	△183.1	△197.0	△191.3	△202.1
営業費 Operating Expenses	937.9	1,020.9	899.8	801.9	895.9	997.3	1,193.1	1,153.7	1,135.8	1,159.1	1,157.9	1,165.6	1,159.7	1,137.4	1,160.0	1,168.3	1,188.4
運輸業 Transportation	-	-	-	-	764.2	782.5	870.3	846.6	839.8	846.9	815.9	833.6	801.2	787.2	800.9	796.4	813.6
流通業 Merchandise and Other	-	-	-	-	100.7	160.8	184.8	189.8	199.5	202.2	212.5	224.9	230.9	229.5	247.1	255.3	255.8
不動産業 Real Estate	-	-	-	-	21.1	39.8	60.0	54.5	49.6	52.2	53.5	49.9	50.4	50.5	59.4	61.8	60.9
その他 Other	-	-	-	-	81.7	107.4	245.2	228.6	214.3	223.7	240.0	230.6	244.7	252.2	248.4	244.9	258.7
調整額 Reconciliations	-	-	-	-	△71.9	△93.3	△167.3	△166.0	△167.6	△166.0	△164.2	△173.5	△167.6	△182.1	△196.0	△190.2	△200.7
営業利益 Operating Income	114.3	133.8	288.4	406.7	325.6	335.9	293.4	349.3	372.5	426.1	494.6	506.5	578.6	619.5	662.0	709.7	656.1
運輸業 Transportation	-	-	-	-	323.6	321.0	272.0	323.0	342.8	396.1	460.1	472.0	556.8	593.1	623.0	664.8	617.6
流通業 Merchandise and Other	-	-	-	-	△2.4	2.5	3.7	5.1	5.7	7.2	8.2	8.9	8.7	7.5	8.2	9.6	7.4
不動産業 Real Estate	-	-	-	-	3.2	10.0	6.7	11.8	13.0	12.7	13.8	16.6	15.6	18.1	18.5	20.2	19.0
その他 Other	-	-	-	-	1.7	3.2	10.3	10.9	11.4	9.4	10.5	8.2	△1.7	1.6	13.2	16.1	13.5
調整額 Reconciliations	-	-	-	-	△0.6	△0.9	0.6	△1.7	△0.6	0.5	1.8	0.7	△0.8	△0.9	△1.0	△1.1	△1.3
経常利益 Ordinary Income	109.4	130.3	118.2	69.5	67.0	72.3	165.2	228.5	263.8	328.0	404.2	428.1	511.4	563.9	583.5	632.6	574.2
親会社株主に帰属する当期純利益 Net income attributable to owners of the parent	66.9	53.3	56.4	33.8	37.6	52.9	91.7	133.8	132.7	199.9	255.6	264.1	337.4	392.9	395.5	438.7	397.8
資産合計 Total Assets	947.0	1,089.2	6,230.2	6,245.9	6,061.6	5,919.2	5,211.0	5,252.9	5,214.0	5,231.1	5,178.1	5,217.9	5,268.5	7,052.6	8,908.6	9,295.7	9,603.1
負債合計 Total Liabilities	665.6	754.5	5,856.0	5,849.0	5,470.9	5,284.8	4,076.4	4,006.8	3,850.7	3,673.1	3,375.9	3,154.0	2,915.9	4,325.9	5,823.9	5,787.6	5,731.0
長期債務 Long-Term Debt and Payables	352.8	377.9	5,460.5	5,435.2	4,942.2	4,710.2	3,173.5	3,045.3	2,866.7	2,639.9	2,370.8	2,150.5	1,945.0	3,395.4	4,856.2	4,851.1	4,846.0
純資産合計 Total Equity	281.3	334.6	374.2	396.9	584.3	626.6	1,134.5	1,246.1	1,363.2	1,557.9	1,802.2	2,063.9	2,352.5	2,726.7	3,084.7	3,508.0	3,872.1

注 1.平成4(1992)年以前の長期債務は参考値
2.平成10(1998)年度から会計制度の変更により、事業税の計上箇所を営業費より法人税等に変更
3.平成10(1998)年度から会計制度の変更により、非支配株主持分を負債に含めず表記
4.平成18(2006)年度から会計制度の変更により、「資本」表記を「純資産」表記に変更、「純資産」には非支配株主持分を含む
5.平成26(2014)年度以前の親会社株主に帰属する当期純利益は、期末連結決算における当期純利益を記載

Notes: 1.The numbers of Long-Term Debt and Payables before FY1992 are references.
2.Due to a change in Japanese accounting standards, enterprise tax, which was recorded as an operating expense, is recorded as a part of income taxes from FY1998.
3.Due to a change in Japanese accounting standards, noncontrolling interests are excluded from liabilities from FY1998.
4.Due to a change in Japanese accounting standards, "Shareholders' equity" changed to "Equity" from FY2006. Noncontrolling interests are included in "Equity".
5.For FY1989 through FY2014, the "Net income attributable to owners of the parent" is based on the "Net income" of financial reports.

■ 対象会社数 Consolidation (各年度末時点 at fiscal year-end)

連結 Number of Consolidated Subsidiaries	3	3	3	5	19	30	31	29	29	29	29	29	28	29	29	29	29
持分法適用 Number of Affiliates Accounted for by the Equity Method	0	0	0	0	1	2	2	2	2	2	2	2	2	2	2	2	2

■ 設備投資額、減価償却費 Capital Investment, Depreciation and Amortizations

(10億円 ¥ billion)

設備投資額 Capital Investment	-	-	-	-	223.3	175.7	267.3	298.9	316.6	318.3	240.6	272.3	279.9	374.9	379.6	467.3	524.0
減価償却費 Depreciation and Amortization	-	-	-	-	218.1	220.7	268.2	258.5	257.0	240.1	276.2	271.5	242.3	225.3	216.0	211.2	214.5

■ 連結キャッシュ・フロー計算書 Consolidated Cash Flow Statements (抜粋 abstract)

(10億円 ¥ billion)

営業活動によるキャッシュ・フロー Net Cash Provided by (Used in) Operating Activities	-	-	-	-	300.3	353.2	414.0	521.9	447.6	512.3	540.5	570.8	601.4	580.5	609.5	600.3	595.2
投資活動によるキャッシュ・フロー Net Cash Provided by (Used in) Investing Activities	-	-	-	-	△196.2	△126.9	△256.2	△320.2	△269.9	△262.1	△230.4	△263.9	△170.3	△1,909.5	△1,676.4	△597.5	△552.4
有形・無形固定資産の取得等による支出 Expenditures from the purchase of property plant and equipment and intangible assets, etc.	-	-	-	-	-	-	-	-	-	-	-	-	△252.3	△330.1	△306.9	△397.8	△459.0
中央新幹線建設資金管理信託による収入・支出 Proceeds from the trust for the Chuo Shinkansen construction	-	-	-	-	-	-	-	-	-	-	-	-	-	△1,472.7	△1,368.1	170.3	235.5
資金運用による収入・支出 Revenue/expenditure from fund management	-	-	-	-	-	-	-	-	-	-	-	-	82.0	△106.7	△1.3	△370.0	△328.9
フリー・キャッシュ・フロー Free Cash Flow (Operating plus Investing)	-	-	-	-	104.1	226.3	157.8	201.7	177.7	250.2	310.1	306.8	431.1	△1,328.9	△1,066.8	2.8	42.7
財務活動によるキャッシュ・フロー Net Cash Provided by (Used in) Financing Activities	-	-	-	-	△101.9	△266.2	△133.6	△165.9	△208.5	△259.8	△309.7	△252.2	△242.8	1,425.1	1,434.7	△33.6	△32.9
現金及び現金同等物の増減額 Net Increase (Decrease) in Cash and Cash Equivalents	-	-	-	-	2.2	△39.9	24.1	35.8	△30.8	△9.6	0.3	54.5	188.3	96.2	367.8	△30.8	9.7

※1 平成3(1991)年10月に東海道新幹線に係る鉄道施設を譲り受け、その譲渡価額5兆956億円を鉄道施設購入長期未払金として計上 ※1 Long-term accounts payable -railway facilities were incurred in the amount of ¥5,095.6 billion in October 1991 for the purchase of the facilities of the Tokaido Shinkansen.
※2 平成12(2000)年5月にJRセントラルタワーズ全全面開業 ※2 JR Central Towers fully opened in May 2000.

注 記載が省略されている年度の数値は以下をご覧ください。
URL <https://company.jr-central.co.jp/ir/factsheets/>

Note: The data of each year omitted here can be found at the URL below
URL <https://company.jr-central.co.jp/ir/factsheets/>

■ EBITDAと売上高当期純利益の推移 EBITDA and Net Income/Operating Revenues

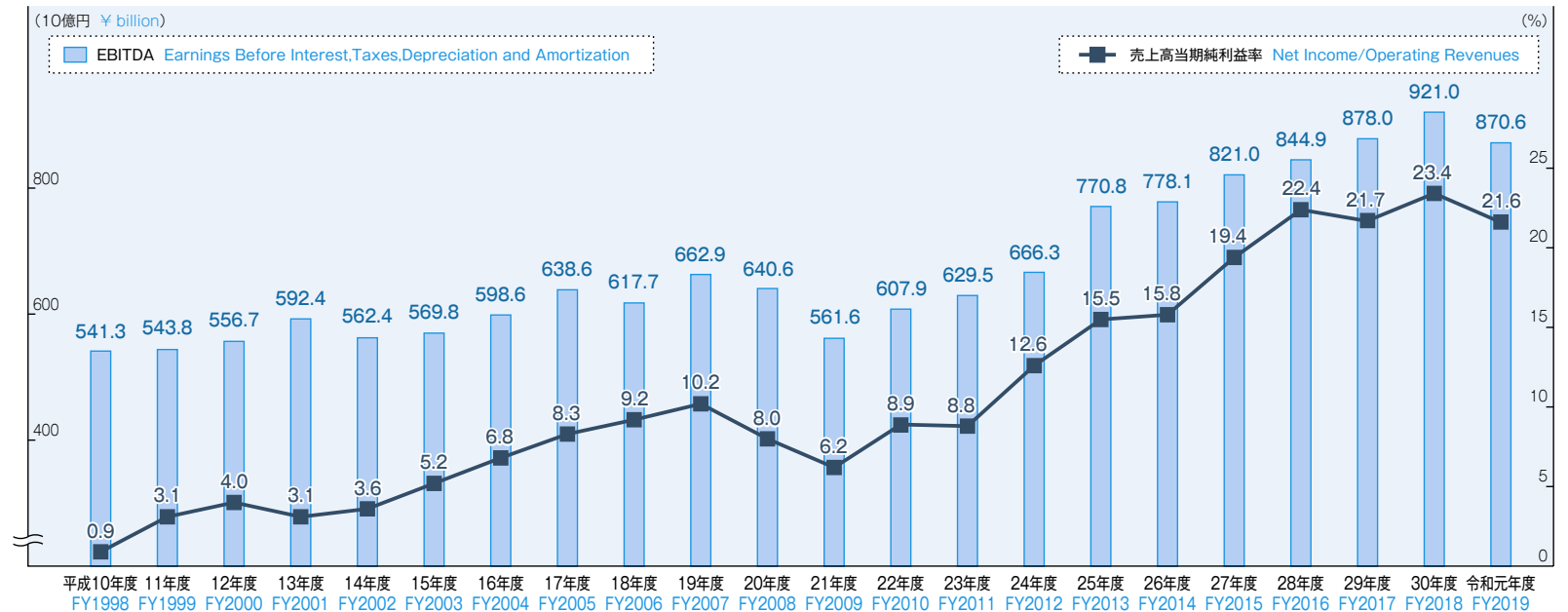

■ 連結 Consolidated

		平成10年度 FY1998	11年度 FY1999	12年度 FY2000	13年度 FY2001	14年度 FY2002	15年度 FY2003	16年度 FY2004	17年度 FY2005	18年度 FY2006	19年度 FY2007	20年度 FY2008	21年度 FY2009	22年度 FY2010	23年度 FY2011	24年度 FY2012	25年度 FY2013	26年度 FY2014	27年度 FY2015	28年度 FY2016	29年度 FY2017	30年度 FY2018	令和元年度 FY2019	
自己資本当期純利益率(ROE) Return on Equity	%	2.3	7.1	8.7	6.5	7.2	9.9	11.9	13.4	15.6	18.7	13.1	8.7	11.6	10.5	14.1	15.7	14.0	15.6	15.7	13.8	13.4	10.9	
売上高当期純利益率 Net Income/Operating Revenues	%	0.9	3.1	4.0	3.1	3.6	5.2	6.8	8.3	9.2	10.2	8.0	6.2	8.9	8.8	12.6	15.5	15.8	19.4	22.4	21.7	23.4	21.6	
総資産回転率 Asset Turnover	回 Times	0.2	0.2	0.2	0.2	0.2	0.3	0.3	0.3	0.3	0.3	0.3	0.3	0.3	0.3	0.3	0.3	0.3	0.3	0.3	0.3	0.2	0.2	0.2
財務レバレッジ Financial Leverage	倍 Times	12.7	10.4	9.4	8.6	8.0	7.1	6.2	5.5	6.5	5.6	5.2	4.8	4.4	3.9	3.5	3.0	2.6	2.3	2.6	2.9	2.7	2.5	
総資産営業利益率 Operating Income/Total Assets	%	5.6	5.4	5.6	6.4	6.1	6.2	6.5	7.6	7.7	8.4	7.4	5.6	6.7	7.1	8.2	9.5	9.7	11.0	10.1	8.3	7.8	6.9	
自己資本比率 Equity Ratio	%	7.9	9.6	10.6	11.6	12.4	14.0	16.0	18.3	15.3	17.8	19.4	21.0	23.0	25.3	28.9	33.9	38.7	44.0	38.2	34.3	37.3	39.9	
負債比率 Debt to Equity Ratio	%	1,164.9	936.2	843.4	760.6	702.1	613.0	522.7	443.8	552.1	461.0	412.8	371.7	332.1	291.4	242.7	192.5	156.1	125.9	160.7	190.6	166.7	149.6	
インタレストカバレッジレシオ Interest Coverage Ratio	倍 Times	1.3	1.3	1.4	1.7	1.6	1.8	1.9	2.5	2.7	3.2	3.0	2.5	3.2	3.8	4.8	6.2	7.0	8.9	10.3	8.5	8.9	8.3	
EBITDA Earnings Before Interest, Taxes, Depreciation and Amortization	10億円 ¥Billion	541.3	543.8	556.7	592.4	562.4	569.8	598.6	638.6	617.7	662.9	640.6	561.6	607.9	629.5	666.3	770.8	778.1	821.0	844.9	878.0	921.0	870.6	
1株当たり当期純利益 Earnings per Share	円 ¥	4,860	16,820	23,643	18,790	21,801	32,172	42,806	54,560	69,407	81,106	64,023	46,574	67,990	674	1,016	1,299	1,342	1,714	1,996	2,015	2,238	2,027	
1株当たり純資産 Shareholders' Equity per Share	円 ¥	211,339	260,872	279,733	295,144	310,030	342,126	379,871	434,917	400,896	464,467	513,233	555,999	613,134	6,715	7,689	8,911	10,265	11,770	13,681	15,602	17,703	19,514	
1株当たり配当額 Dividend per Share	円 ¥	5,000	5,000	5,000	5,000	5,000	5,000	5,500	6,500	7,500	8,500	9,000	9,000	9,500	105	115	120	125	125	135	140	145	150	
配当性向 Dividend Payout Ratio	%	102.9	29.7	21.1	26.6	22.9	15.5	12.8	11.9	10.8	10.5	14.1	19.3	13.2	14.1	10.3	8.9	8.9	7.3	6.8	6.9	6.5	7.4	
純資産配当率 Dividend on Equity Ratio	%	2.4	2.1	1.8	1.7	1.7	1.5	1.5	1.6	1.8	2.0	1.8	1.7	1.5	1.5	1.5	1.4	1.3	1.1	1.1	1.0	0.9	0.8	

注 1. EBITDAは 営業利益+減価償却費 により算出
 2. インタレストカバレッジレシオは(営業利益+受取利息・配当金)/支払利息 で計算
 3. 平成24(2012)年度の1株当たりの数値については、平成24(2012)年10月1日を効力発生日として、普通株式1株を100株に分割し、1単元の株式の数を100株とする単元株制度を採用したことを受け、期首に当該株式分割が行われたと仮定して算定

Notes: 1. EBITDA represents operating income plus depreciation and amortization.
 2. Interest coverage ratio is calculated as "the sum of operating income and interest and dividend income" divided by "interest expense".
 3. As of the effective date, October 1, 2012, the Company split 1 share of common stock into 100 shares, and adopted a share unit system under which the number of shares constituting 1 unit is 100 shares. Therefore, the Company calculated Shareholders' Equity per Share, EPS and Dividend per Share on the basis that such stock split was made at the beginning of the previous consolidated fiscal year and previous business year.

■ 単体 Non-consolidated

		30.3	30.0	29.4	31.6	29.3	29.0	28.8	32.0	31.4	32.7	29.2	24.0	27.8	29.2	32.1	36.1	36.4	41.1	43.2	43.8	45.6	43.4
売上高営業利益率 Operating Income/Operating Revenues	%																						
売上高経常利益率 Ordinary Income/Operating Revenues	%	6.5	6.4	5.9	7.5	8.2	10.4	11.1	16.3	17.9	20.3	16.1	13.0	17.7	20.2	24.3	29.1	30.4	36.1	39.2	38.4	40.3	37.6
売上高当期純利益率 Net Income/Operating Revenues	%	1.1	3.8	4.6	3.7	3.9	5.9	7.9	9.7	10.7	12.2	9.8	7.7	10.5	10.2	15.1	18.8	19.9	24.2	27.7	26.9	28.3	26.4

経営指標の推移 Financial Statement Ratios

国鉄改革 Restructuring of Japanese National Railways (JNR)

国鉄の分割・民営化の概要 Outline of the Breakup and Privatization of JNR (April 1, 1987)

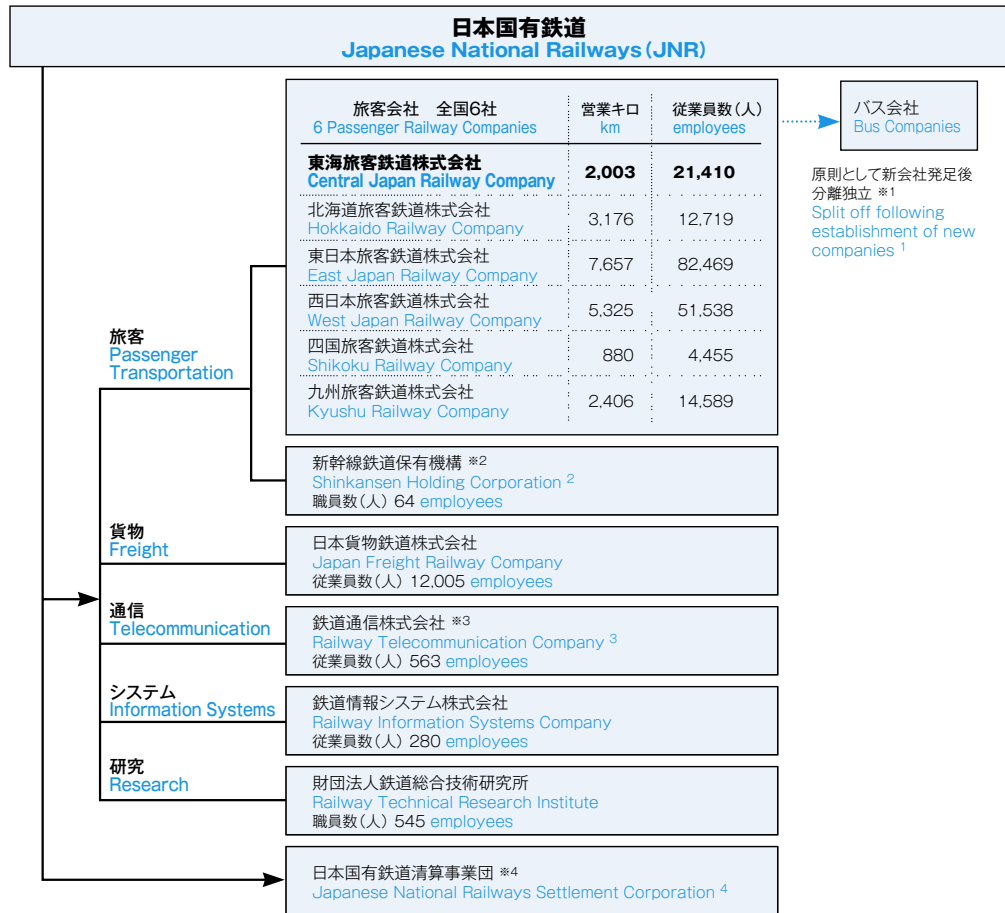

注 1.本州旅客3社のバス事業は、昭和63(1988)年4月に分離され、当該旅客会社の100%出資会社となりました。
 2.新幹線鉄道保有機構は、平成3(1991)年10月に鉄道整備基金に承継されました。その後、運輸施設整備事業団を経て、平成15(2003)年10月に独立行政法人鉄道建設・運輸施設整備支援機構に承継されました。
 3.鉄道通信株式会社は、平成元(1989)年5月に(旧)日本テレコム株式会社と合併し、商号を日本テレコム株式会社に変更し、さらに平成18(2006)年10月にソフトバンクテレコム株式会社に変更しました。ソフトバンクテレコム株式会社は、平成27(2015)年4月にソフトバンクモバイル株式会社に吸収合併されました。
 4.日本国有鉄道清算事業団は、平成10(1998)年10月に解散し、日本鉄道建設公団に承継されました。日本鉄道建設公団と運輸施設整備事業団は平成15(2003)年10月に独立行政法人鉄道建設・運輸施設整備支援機構に承継されました。

Notes: 1.The bus operations of three JR companies on Honshu (JR Central, JR East, and JR West) were split off as wholly owned subsidiaries in April 1988.
 2.The Shinkansen Holding Corporation was succeeded by the Railway Development Fund in October 1991. The Railway Development Fund was succeeded by the Corporation for Advanced Transport and Technology (CATT), and the CATT was succeeded by The Japan Railway Construction, Transport and Technology Agency (JRTC) in October 2003.
 3.The Railway Telecommunication Company merged with former Japan Telecom in May 1989. The new company retained the name Japan Telecom Co., Ltd., and the company changed the name to Softbank Telecom Corp. in October 2006. Softbank Telecom Corp. was taken over by Softbank Mobile Corp. in April 2015.
 4.The Japanese National Railway Settlement Corporation was succeeded in October 1998 by the Japanese Railway Construction Public Corporation (JRCC). The JRCC was established in October 2003 as a result of the merger of the JRCC and the CATT.

新幹線資産・債務の配分 Valuation of Shinkansen Assets (兆円 ¥ trillion)

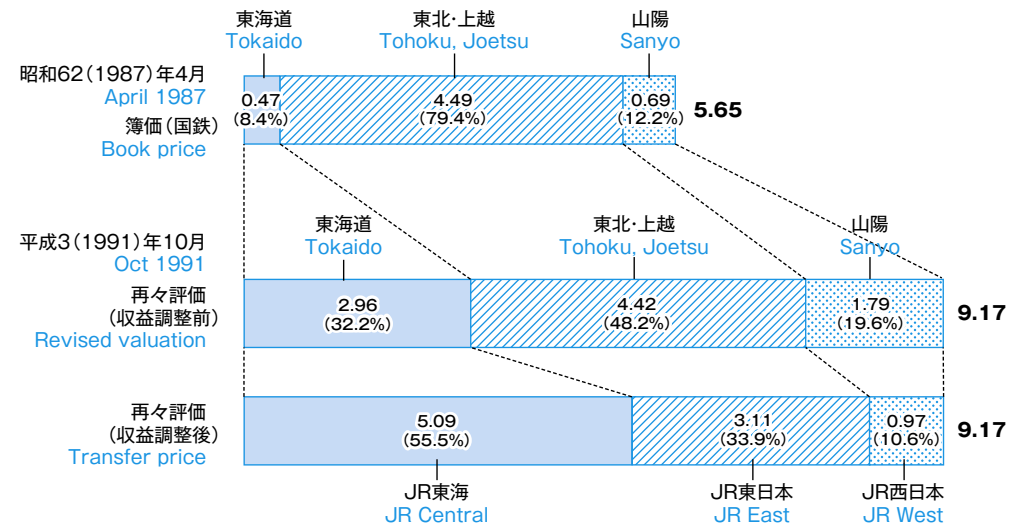

旅客会社6社の営業エリア Operating Areas of Six Passenger Railway Companies

